

# Operating Instructions

## Tankvision

### Tank Scanner NXA820, Data Concentrator NXA821, Host Link NXA822

#### Operator Manual



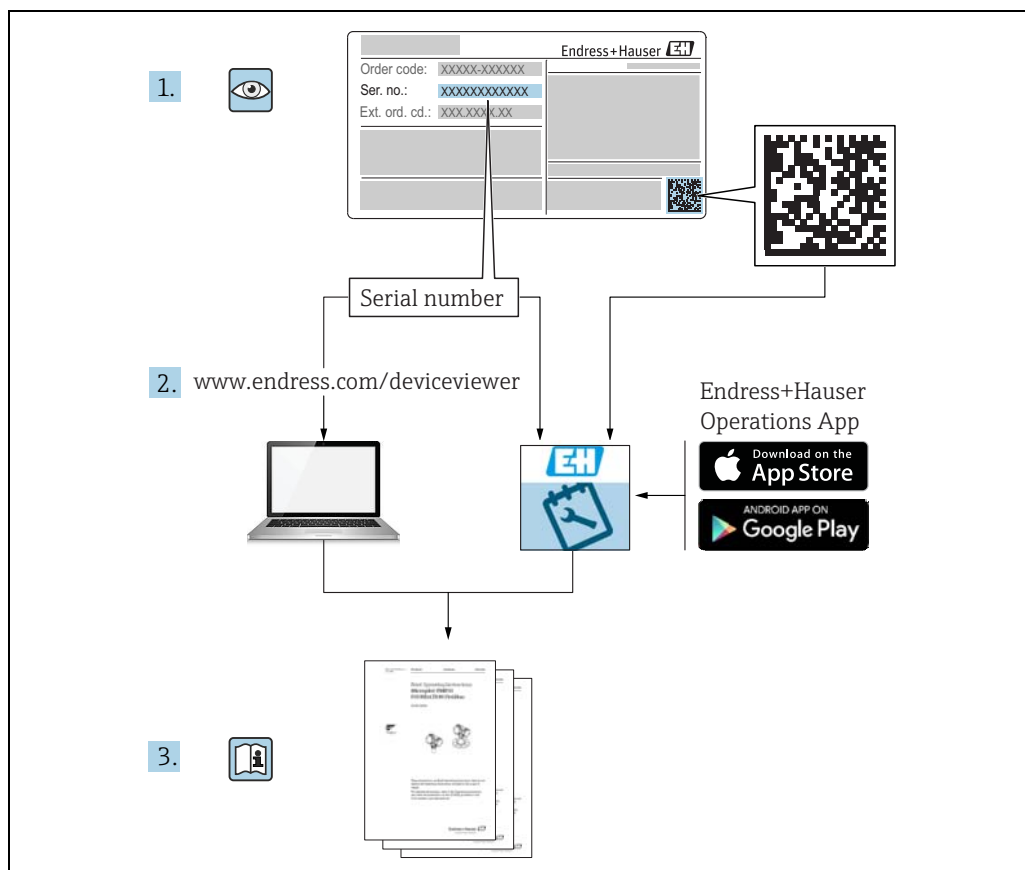

A0023555

Make sure the document is stored in a safe place such that it is always available when working on or with the device.  
 To avoid danger to individuals or the facility, read the "Basic safety instructions" section carefully, as well as all other safety instructions in the document that are specific to working procedures.  
 The manufacturer reserves the right to modify technical data without prior notice. Your Endress+Hauser distributor will supply you with current information and updates to these Instructions.

## Change history

Document version	Valid for SW version	Changes to the previous version
BA00424G/15.17	02.00.00	Introduced Temperature and Density Profile
BA00424G/16.17	02.01.00	Introduced Floating Roof Weight Correction, Redundancy functionality with NXA820 Interface Only, CH alarm for Volume or Mass
BA00424G/18.18	02.02.00	Introduced Switch by Gauge redundancy mode for NXA820 Interface Only
BA00424G/19.20	02.03.00	Introduced tank comment fields and improved the change alarm functions
BA00424G/19.23-00	02.03.01	Bug fix version

# Table of Contents

<b>1</b>	<b>About this document</b> . . . . .	<b>4</b>	<b>9</b>	<b>Maintenance</b> . . . . .	<b>76</b>
1.1	Document function . . . . .	4	<b>10</b>	<b>Repair</b> . . . . .	<b>76</b>
1.2	Symbols . . . . .	4	10.1	Return . . . . .	76
1.3	Documentation . . . . .	5	10.2	Disposal . . . . .	76
1.4	Registered trademarks . . . . .	5			
<b>2</b>	<b>Basic safety instructions</b> . . . . .	<b>6</b>		<b>Index</b> . . . . .	<b>77</b>
2.1	Requirements for the personnel . . . . .	6			
2.2	Intended use . . . . .	6			
2.3	Workplace safety . . . . .	6			
2.4	Operational safety . . . . .	6			
2.5	Product safety . . . . .	7			
2.6	IT security . . . . .	7			
<b>3</b>	<b>Incoming acceptance and product identification</b> . . . . .	<b>8</b>			
3.1	Incoming acceptance . . . . .	8			
3.2	Product identification . . . . .	8			
3.3	Manufacturer address . . . . .	9			
3.4	Storage and Transport, . . . . .	9			
<b>4</b>	<b>Recommendation PC configuration</b> . . . . .	<b>9</b>			
<b>5</b>	<b>User interface</b> . . . . .	<b>10</b>			
<b>6</b>	<b>User access rights</b> . . . . .	<b>13</b>			
<b>7</b>	<b>Operations</b> . . . . .	<b>15</b>			
7.1	How to log on? . . . . .	15			
7.2	How to view tank details . . . . .	17			
7.3	How to view Temperature Profiles . . . . .	25			
7.4	How to view Density Profiles . . . . .	26			
7.5	How to view and enter Manual Data . . . . .	27			
7.6	How to enter dipped data . . . . .	29			
7.7	How to issue gauge commands . . . . .	29			
7.8	How to view a real time trend . . . . .	34			
7.9	How to assign/change products at a tank . . . . .	37			
7.10	How to do Product transfer . . . . .	38			
7.11	How to view a Transfer report . . . . .	44			
7.12	How to view and change Tank Status . . . . .	45			
7.13	How to do tank calculations . . . . .	48			
7.14	How to view products groups . . . . .	49			
7.15	How to view customized groups . . . . .	52			
7.16	How to view transfer groups . . . . .	55			
7.17	How to issue reports . . . . .	56			
7.18	How to view and acknowledge alarms . . . . .	63			
7.19	How to select and view historical trends . . . . .	70			
7.20	How to check the sealing status . . . . .	72			
<b>8</b>	<b>Diagnostics and troubleshooting</b> . . . . .	<b>75</b>			
8.1	General troubleshooting . . . . .	75			

# 1 About this document





## 1.1 Document function

This manual should support the operating personal working on a regular basis with the Tank Gauging System understanding the possible tasks they have to perform and should serve as encyclopedia for those tasks.





Beside basic PC operating knowledge no special training is needed to perform the Tank Gauging System operations. Nevertheless it is recommended receiving a training on the system by Endress+Hauser.

## 1.2 Symbols



### 1.2.1 Safety symbols

Symbol	Meaning
 <small>A0011189-EN</small>	<b>DANGER!</b> This symbol alerts you to a dangerous situation. Failure to avoid this situation will result in serious or fatal injury.
 <small>A0011190-EN</small>	<b>WARNING!</b> This symbol alerts you to a dangerous situation. Failure to avoid this situation can result in serious or fatal injury.
 <small>A0011191-EN</small>	<b>CAUTION!</b> This symbol alerts you to a dangerous situation. Failure to avoid this situation can result in minor or medium injury.
 <small>A0011192-EN</small>	<b>NOTICE!</b> This symbol contains information on procedures and other facts which do not result in personal injury.



### 1.2.2 Electrical symbols

Symbol	Meaning
 <small>A0011197</small>	<b>Direct current</b> A terminal to which DC voltage is applied or through which direct current flows.
 <small>A0011198</small>	<b>Alternating current</b> A terminal to which alternating voltage is applied or through which alternating current flows.
 <small>A0011200</small>	<b>Ground connection</b> A grounded terminal which, as far as the operator is concerned, is grounded via a grounding system.
 <small>A0011199</small>	<b>Protective ground connection</b> A terminal which must be connected to ground prior to establishing any other connections.

### 1.2.3 Symbols for certain types of information

Symbol	Meaning
 <small>A0011193</small>	<b>Tip</b> Indicates additional information.
 <small>A0011195</small>	<b>Reference to page</b> Refers to the corresponding page number.
1. , 2. , 3. ...	Series of steps.
 <small>A0018373</small>	Result of a sequence of actions.

### 1.2.4 Symbols in graphics

Symbol	Meaning
1, 2, 3 ...	Item numbers
1. , 2. , 3. ...	Series of steps
A, B, C ...	Views
 <small>A0011187</small>	<b>Hazardous area</b> Indicates a hazardous area.
 <small>A0011188</small>	<b>Indicates a non-hazardous location</b> Safe area (non-hazardous area)

## 1.3 Documentation

The following documentation types are available in the Downloads area of the Endress+Hauser website: [www.endress.com/downloads](http://www.endress.com/downloads)

-  For an overview of the scope of the associated Technical Documentation, refer to the following:
  - *W@M Device Viewer*: [www.endress.com/deviceviewer](http://www.endress.com/deviceviewer) - Enter the serial number from the nameplate
  - *Endress+Hauser Operations App*: Enter the serial number from the nameplate or scan the matrix code on the nameplate

## 1.4 Registered trademarks

Microsoft®, Windows® and Internet Explorer®  
Registered trademarks of the Microsoft Corporation

Modbus™  
Modbus is a registered trademark of Schneider Electric USA, Inc.

Java®  
Registered trademark of Oracle® Corporation

Mozilla® Firefox®  
Registered trademark of the Mozilla Foundation

## 2 Basic safety instructions

### 2.1 Requirements for the personnel

The personnel for installation, commissioning, diagnostics and maintenance must fulfil the following requirements:

- Trained, qualified specialists: must have a relevant qualification for this specific function and task
- Are authorized by the plant owner or operator
- Are familiar with federal or national regulations
- Before starting work, read and understand the instructions in the manual and supplementary documentation as well as the certificates (depending on the application)
- Follow instructions and comply with basic conditions

The operating personnel must fulfil the following requirements:

- Are instructed and authorized according to the requirements of the task by the facility's owner-operator
- Following the instructions in these Operating Instructions

### 2.2 Intended use

#### 2.2.1 Application

Tankvision is a dedicated tank inventory management system.

Components:

- Tankvision Tank Scanner NXA820  
scans parameters from tank gauges and performs tank calculations
- Tankvision Data Concentrator NXA821  
summarizes data from various Tank Scanners NXA820
- Tankvision Host Link NXA822  
provides data to host systems (such as PLC or DCS) via Modbus

The above mentioned components are operated via a standard web browser. It does not require any proprietary software. Tankvision is based on a distributed architecture on a Local Area Network (LAN). Due to its modular structure it can be adjusted to any application. It is ideally suited for small tank farms with only a couple of tanks, but also for large refineries with hundreds of tanks.

### 2.3 Workplace safety

For work on and with the device:

- Wear the required personal protective equipment according to federal/national regulations.
- Switch off the supply voltage before connecting the device.

### 2.4 Operational safety

Risk of injury!

- Operate the device only if it is in proper technical condition, free from errors and faults.
- The operator is responsible for interference-free operation of the device.

#### Modifications to the device

Unauthorized modifications to the device are not permitted and can lead to unforeseeable dangers!

- If modifications are nevertheless required, consult with the manufacturer.

### Repair

To ensure continued operational safety and reliability:

- Carry out repairs on the device only if they are expressly permitted.
- Observe federal/national regulations pertaining to repair of an electrical device.
- Use only original spare parts and accessories.

## 2.5 Product safety

This measuring device is designed in accordance with good engineering practice to meet state-of-the-art safety requirements, has been tested, and left the factory in a condition in which it is safe to operate. It meets general safety standards and legal requirements. It also complies with the EC directives listed in the device-specific EC Declaration of Conformity. Endress+Hauser confirms this by affixing the CE mark to the device.

Furthermore, the device meets the legal requirements of the applicable UK regulations (Statutory Instruments). These are listed in the UKCA Declaration of Conformity along with the designated standards.

By selecting the order option for UKCA marking, Endress+Hauser confirms a successful evaluation and testing of the device by affixing the UKCA mark.

Contact address Endress+Hauser UK:

- Endress+Hauser Ltd.  
Floats Road  
Manchester M23 9NF  
United Kingdom  
[www.uk.endress.com](http://www.uk.endress.com)

### 2.5.1 Degree of protection

- IP20 (as per IEC/EN 60529)
- IK06 (as per IEC/EN 62262)

## 2.6 IT security

We only provide a warranty if the device is installed and used as described in the Operating Instructions. The device is equipped with security mechanisms to protect it against any inadvertent changes to the device settings.

IT security measures in line with operators' security standards and designed to provide additional protection for the device and device data transfer must be implemented by the operators themselves.

Endress+Hauser can be contacted to provide support in performing this task.

## 3 Incoming acceptance and product identification

### 3.1 Incoming acceptance

Upon receipt of the goods check the following:

- Are the order codes on the delivery note and the product sticker identical?
- Are the goods undamaged?
- Do the nameplate data match the ordering information on the delivery note?
- If required (see nameplate): Are the Safety Instructions (XA) enclosed?



If one of these conditions is not satisfied, contact your Endress+Hauser Sales Center.

#### 3.1.1 Delivery content

- Tankvision
- Ferrules for installation on the power supply cable
- Installation Instructions BA00340G/00
- Documentation CD-ROM

### 3.2 Product identification

The following options are available for identification:

- Nameplate specifications
- Extended order code with breakdown of the device features on the delivery note
- *W@M Device Viewer*: Enter the serial number from the nameplate  
[www.endress.com/deviceviewer](http://www.endress.com/deviceviewer)
- Endress+Hauser Operations App: Enter the serial number from the nameplate or scan the matrix code on the nameplate



## Nameplate

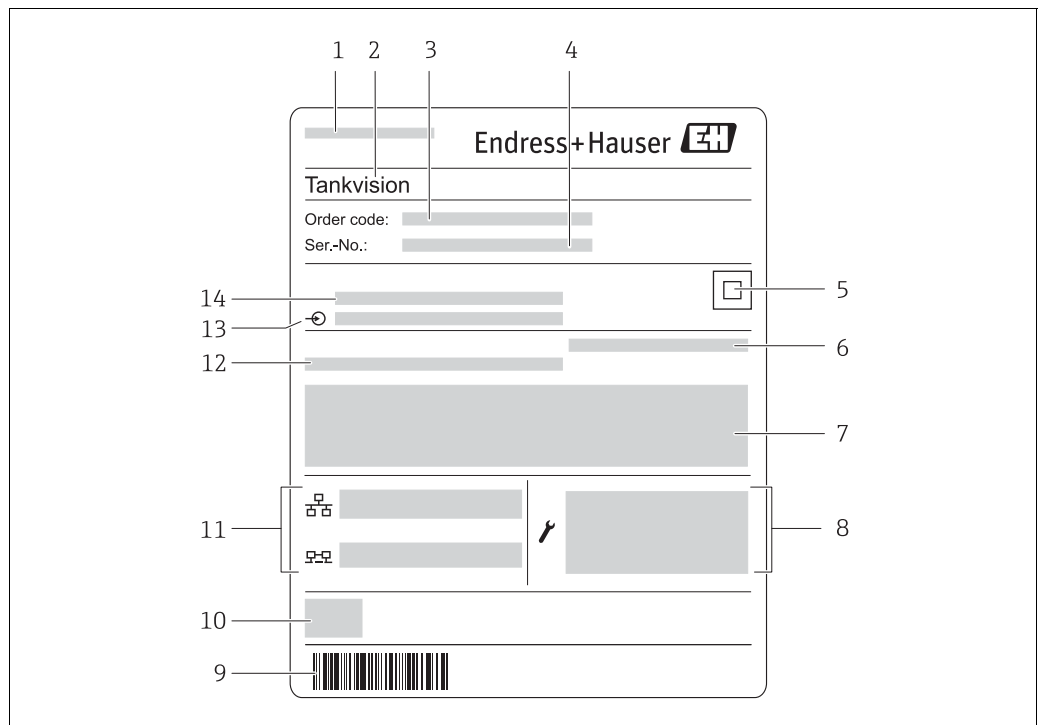

- 1 Address of manufacturer  
 2 Device name  
 3 Order code  
 4 Serial number (Ser. no.)  
 5 Data Matrix Code  
 6 Degree of protection  
 7 Certificate and approval relevant data  
 8 Technical data of the Service LAN port  
 9 Barcode  
 10 CE mark  
 11 MAC address of the System LAN port and Sync LAN port  
 12 Admissible ambient temperature  
 13 Type of fieldbus communication (only for Tank Scanner NXA820)  
 14 Supply voltage

### 3.3 Manufacturer address

Endress+Hauser SE+Co. KG  
 Hauptstraße 1  
 79689 Maulburg, Germany  
 Place of manufacture: See nameplate.

### 3.4 Storage and Transport,

Pack the measuring instrument so that it is protected against impacts for storage and transport. The original packing material provides the optimum protection for this.  
 Permissible storage temperature: -40 to +85 °C (-40 °F to +185 °F).

## 4 Recommendation PC configuration

With all on the market available web browser entering the Tankvision web server is possible. Nevertheless the pages are optimized for Microsoft Internet Explorer (supported version IE9, IE10 and IE11– Compatibility Mode).

The user interface pages are optimized for a screen resolution of 1280x1024 (or higher).

## 5 User interface

Tankvision provides an intuitive user interface allowing the user to quickly navigate through the system. The following sections illustrate various parts of the Tankvision user interface and their usage.

### The Home Page

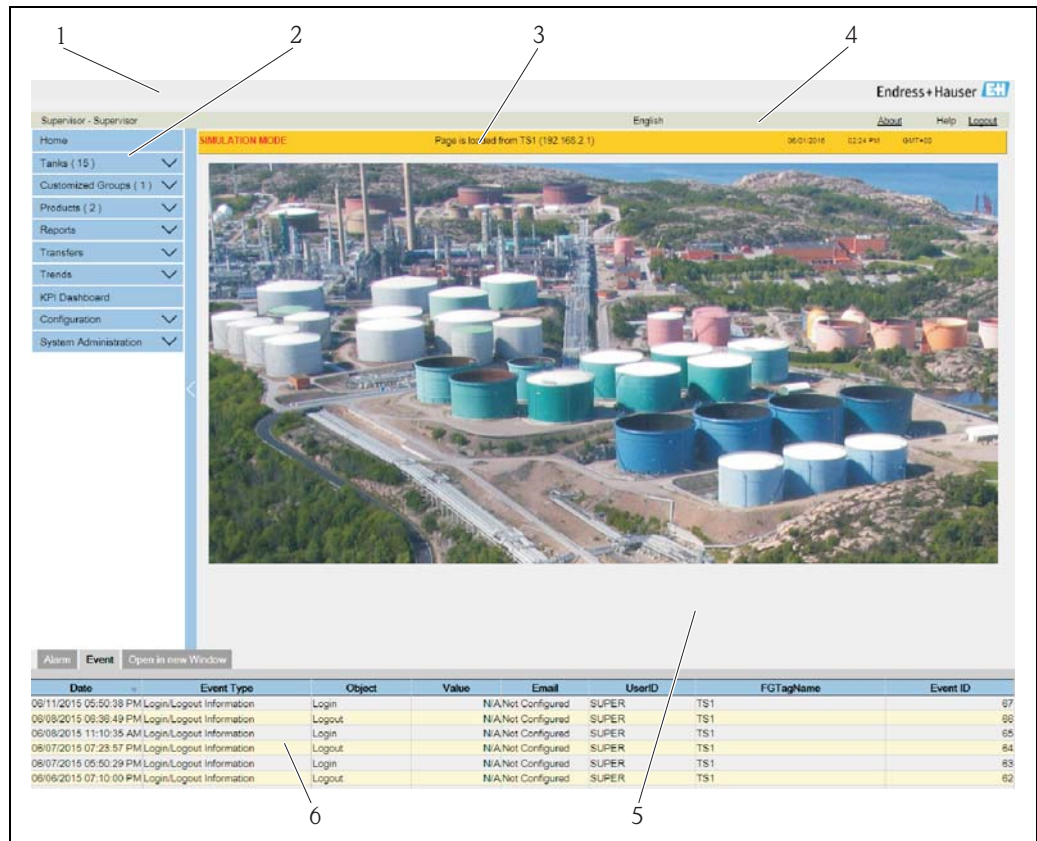

The\_Homepage

Pos.	Field	Description
1	System Header	Displays the Customer Logo or Graphic.
2	Navigation Tree	Contains header bars corresponding to different functional objects or groups in the system. Refer to "Navigation Tree - detailed description" (→ 11) for details.
3	Main Header	Displays the following information: <ul style="list-style-type: none"> <li>The site name, tank name, Tankvision tag name or product name - depending on what is displayed in the Main View below the header</li> <li>The system date and time</li> </ul> The main header is displayed with a background color depending on the access rights of the user logged into the system: <ul style="list-style-type: none"> <li>Grey: the user does not have configuration rights and can only view data.</li> <li>Orange: the user has configuration rights and can view real time data.</li> </ul>
4	Metadata Header	Displays the following information: <ul style="list-style-type: none"> <li>The user name and the user type</li> <li>The language options link</li> <li>The help link</li> <li>The logout option</li> </ul>
5	Main View	Displays the screens that the user has selected to configure the settings and view the operational information. Refer to "Main View Section- Colors in Edit Data" (→ 12) for details.

Pos.	Field	Description
6	Alarm and Event Panel	The Alarm and Event Panel displays the real time information about alarms and events. Refer to "Alarm and Event Panel Section- Description" (→ <a href="#">12</a> ) for details.

### Navigation Tree - Detailed Description

The Navigation Tree is shown on the left side of the screen. Typically, the Navigation Tree allows the user to navigate down to the tanks. The image of the expanded Navigation Tree is as follows:

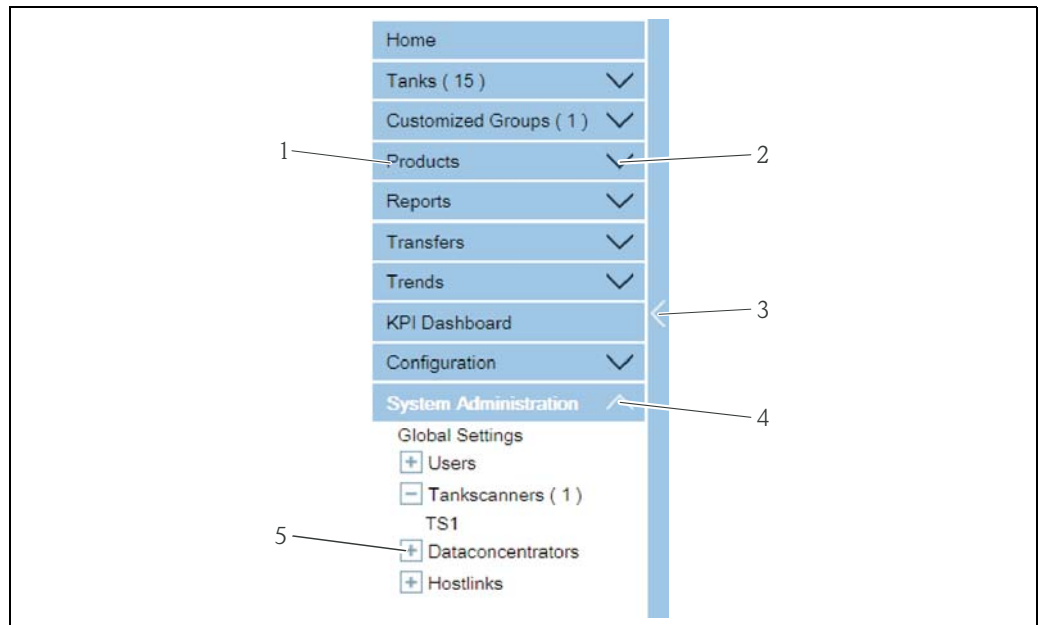

Navigation\_Tree\_Detailed\_EN

Pos.	Field	Description
1	Header	The user can click on the text or the arrow of the Header to expand or collapse the branch. The Header name shows a number, which is dynamically appended. The number states the following: <ul style="list-style-type: none"> <li>▪ Tanks: The number of tanks in the NXA820</li> <li>▪ Products: The number of products defined in the system</li> <li>▪ Customized Groups: The number of tank groups defined in the system</li> <li>▪ Transfers: The number of product transfer stages (Waiting, In Progress, Finished, and Aborted) defined in the system</li> <li>▪ Reports: The list of available system reports</li> <li>▪ Users: The number of users defined in the system</li> <li>▪ Historical Trend: Direct line to the historical Historical Data and Trend functionality</li> </ul> The text will appear in bold and white when the header is in the expanded form.
2	Collapsed Arrow	This type of arrow is displayed when the Header is in the collapsed position. Click on the collapsed arrow to expand the Header.
3	Collapse/Expand Navigation Tree	The user can click on this arrow to collapse or expand the Navigation Tree.
4	Expanded Arrow	This type of arrow is displayed when the Header is in the expanded position. Click on the expanded arrow to collapse the Header.
5	Node	The user can click on the Node to view the operational information on the Main View section. If a Node is selected, it will appear in red color. The number of tanks in the group is appended to the Node name.

### Main View Section - Colors in the Edit Data Area

The system displays different colors in the Edit Data area, based on the access rights of the user:

1. If the user has access rights, then the edit data area has a light grey and light yellow background on alternate rows. The **Submit** button to save the settings is enabled.

Tank Capacity Table Summary:			
Sump & Pipeline Volume:	+0.000	m <sup>3</sup>	TCT Level Type: Innage
Maximum Tank Capacity:	+0.000 m <sup>3</sup>		Minimum pump-able volume: +0.000 m <sup>3</sup>
Volume Calculation Method:	Raw		Number of Straps: 2
Sub Table Present:	No		Water Table Present: No
Product Density for FRA:	+0.0 kg/m <sup>3</sup>		Volumetric Floating Roof Correction: +0.000 m <sup>3</sup>
Heel Volume:	+0.000m <sup>3</sup>		<a href="#">Get TCT file</a>
Static Pressure Table Present:	No		<a href="#">Show TCT file</a>

NXA82x\_Tank-Capacity-Table-Summary

2. If the user does not have access rights, then the edit data area has a light grey and dark grey background on alternate rows. The **Submit** button to save the settings is disabled.

Tank Capacity Table Summary:			
Sump & Pipeline Volume:	+0.000	m <sup>3</sup>	TCT Level Type: Innage
Maximum Tank Capacity:	+0.000 m <sup>3</sup>		Minimum pump-able volume: +0.000 m <sup>3</sup>
Volume Calculation Method:	Raw		Number of Straps: 2
Sub Table Present:	No		Water Table Present: No
Product Density for FRA:	+0.0 kg/m <sup>3</sup>		Volumetric Floating Roof Correction: +0.000 m <sup>3</sup>
Heel Volume:	+0.000m <sup>3</sup>		<a href="#">Get TCT file</a>
Static Pressure Table Present:	No		<a href="#">Show TCT file</a>

NXA82x\_Tank-Capacity-Table-Summary\_Inactive

### Alarm and Event Panel - Description

The Alarm and Event Panel displays the alarm and event information, which is dynamically generated by the system. 200 events are shown.

Alarm		Event		Open in new Window			
Date	Event Type	Object	Value	Email	UserID	FGTagName	Event ID
06/11/2015 05:50:38 PM	Login/Logout Information	Login		N/A Not Configured	SUPER	TS1	67
06/09/2015 06:36:49 PM	Login/Logout Information	Logout		N/A Not Configured	SUPER	TS1	66
06/08/2015 11:10:35 AM	Login/Logout Information	Login		N/A Not Configured	SUPER	TS1	65
06/07/2015 07:23:57 PM	Login/Logout Information	Logout		N/A Not Configured	SUPER	TS1	64
06/07/2015 05:50:29 PM	Login/Logout Information	Login		N/A Not Configured	SUPER	TS1	63
06/06/2015 07:10:00 PM	Login/Logout Information	Logout		N/A Not Configured	SUPER	TS1	62

Events (Overview)

Tab	Description
Alarm	Displays details of the alarms generated by the system.
Events	Displays details of the events generated by the system.
Open in new Window	Opens the Alarm and Event Panel in a new window.

## 6 User access rights

The Tankvision system has an inbuilt authentication mechanism to prevent unauthorized access. The system identifies the user by a unique logon name and password. The system records all the activities performed by each user and allows only a specific number of users from each user type to be logged in at the same time. This can be configured in system settings by an authorized entity. Each Tankvision unit has an option to confine user access rights data for local use within the unit or enable user access rights data for the central Tankvision unit thereby allowing the user to access all the units that are configured to the central Tankvision unit.



All in this manual described functionality is based on the default settings for the role of the "Operator". The operator is not allowed to perform any changes in the user access rights.

In case the "Operator" is allowed to perform other operations than the ones specified with the default settings refer to the "Description of Instrument Functions" - BA00339F/00/EN.

Data Element	Operator	Supervisor	Technician
File Access:	N/A	<input checked="" type="checkbox"/>	<input checked="" type="checkbox"/>
Configuration Access:	<input type="checkbox"/>	<input checked="" type="checkbox"/>	<input checked="" type="checkbox"/>
Change Tank Group Settings:	<input type="checkbox"/>	<input checked="" type="checkbox"/>	<input checked="" type="checkbox"/>
Change Alarm Settings:	<input type="checkbox"/>	<input checked="" type="checkbox"/>	<input checked="" type="checkbox"/>
Allow Alarm Acknowledge:	<input checked="" type="checkbox"/>	<input checked="" type="checkbox"/>	<input checked="" type="checkbox"/>
Allow Tank Operations:	<input checked="" type="checkbox"/>	<input checked="" type="checkbox"/>	<input checked="" type="checkbox"/>
Change Product Settings:	<input type="checkbox"/>	<input checked="" type="checkbox"/>	<input checked="" type="checkbox"/>
Perform Product Transfer:	<input checked="" type="checkbox"/>	<input checked="" type="checkbox"/>	<input checked="" type="checkbox"/>
Perform Gauge Commands:	<input checked="" type="checkbox"/>	<input checked="" type="checkbox"/>	<input checked="" type="checkbox"/>
Change User Settings:	N/A	<input checked="" type="checkbox"/>	<input checked="" type="checkbox"/>
View Trend and Change Trend's parameters:	<input checked="" type="checkbox"/>	<input checked="" type="checkbox"/>	<input checked="" type="checkbox"/>
Perform Archive Export:	<input checked="" type="checkbox"/>	<input checked="" type="checkbox"/>	<input checked="" type="checkbox"/>
View KPI Dashboard:	<input type="checkbox"/>	<input checked="" type="checkbox"/>	<input checked="" type="checkbox"/>

NXA82x\_Manage-User-Group-Access-Rights

Field	Description
Logon Required	Select the check box to prompt the user to log on to access the Tankvision system. Clear the check box to allow the user to access any feature of the Tankvision system without logging in to the system. This Field indicates whether the user needs to logon to the system to access the Tankvision functionality.

Column	Description
Data Element	This column displays a list of Data Elements, which are accessible only to specific user groups. To obtain access to these elements, the user with valid access rights (for example, supervisor/ technician) needs to allot access rights to the user group.
Operator	An operator performs day-to-day operations at the tank farm and can view refreshed data and alarm notifications. Select the appropriate check box to allow the operator group to access the relevant Data Element.
Supervisor	A supervisor configures and maintains the Tankvision system. He can view refreshed data and alarm notifications. Select the appropriate check box to allow the supervisor group to access the relevant Data Element.
Technician	A technician is a service person from Endress+Hauser who performs the initial setup and configuration of the Tankvision system. Select the appropriate check box to allow the technician group to access a particular Data Element.

Data Elements	Description
File Access	Access to allow file upload or download e.g. Firmware or web page templates
Configuration Access	Access to change configuration

Data Elements	Description
Change Tank Group Settings	Allows to add, modify and delete tank group settings for static and dynamic tank groups
Change Alarm Settings	Allows to create, modify and delete alarm configurations
Allow Alarm Acknowledge	Allows to acknowledge active alarms
Allow Tank Operations	Allows to change tank status, product contents and enter manual data operations
Change Product Settings	Allows to create, modify and delete products
Perform Product Transfer	Allows to arm, start and stop product movements
Perform Gauge Commands	Allows to issue, kill and schedule gauge commands
Change User Settings	Allows to add, modify and delete users, and modify user access rights
View Trend and Change Trend's parameters	Allows to configure real time and historical trend, and start or stop the real time and historical trends
Perform Archive Export	Allows the export of the archive.
View KPI Dashboard	Allows to view the KPI Dashboard.

## 7 Operations

### 7.1 How to log on?

The below described operations can be performed with the default user access rights for an operator ("User access rights", → 13).

The user interface is reached via standard web browsers whereas the recommended web browser is Microsoft Internet Explorer.

1. Open a browser window (depending on the PC configuration this point might be skipped as opening a browser window is configured to be in the auto start and can't be closed without the necessary PC access rights).
2. Type in the IP address  
IP addresses are specific for every single Tankvision units in the system (example IP address 192.168.2.1). Depending on the browser configuration this point might be skipped as it is recommended to select the Tankvision IP address as home page which is automatically opened the browser starts up.
3. The user interface opens and is ready for operation. Per default Tankvision is delivered without a logon required. In this case the default user access rights are set to Operator. The following screens opens:

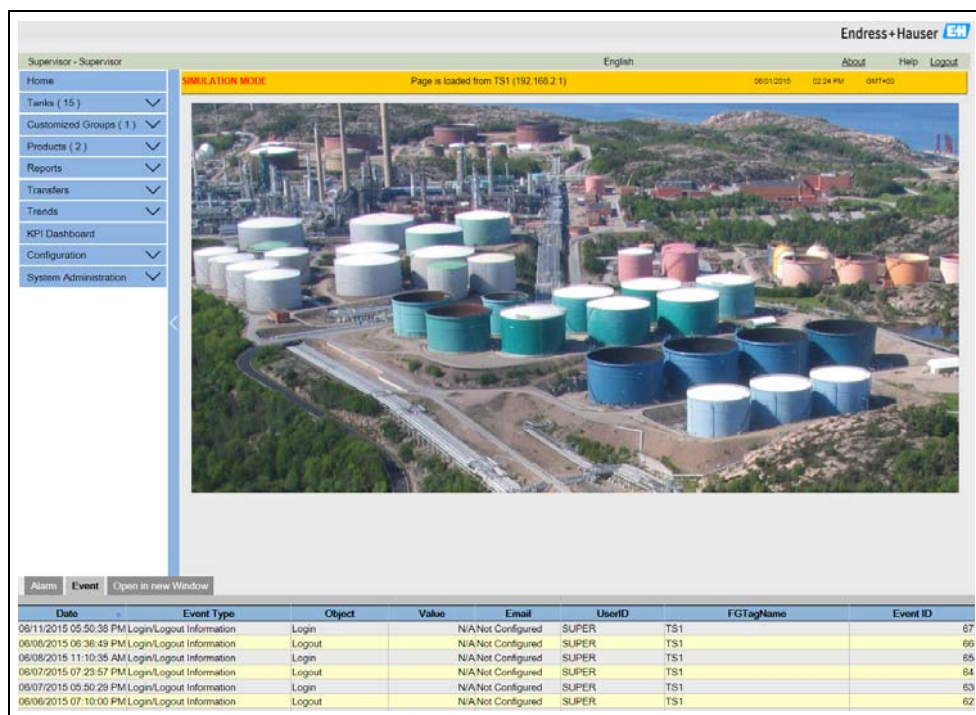

If **Logon required** is selected in the user access rights (done during commissioning by the supervisor) the following screen opens before the above:

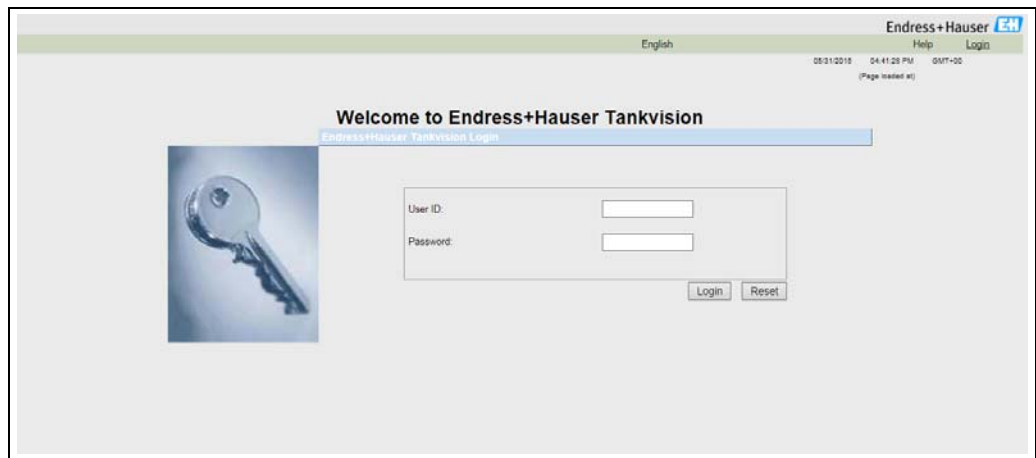

NXA82x\_Login-Screen

Field	Description
User ID	Enter the appropriate user login name . The user login name is alphanumeric and case sensitive.
Password	Enter the appropriate password. The user password is alphanumeric and case sensitive. It consists of 3 to 8 characters.

User ID and the according Password are created during commissioning. Factory default:

- User ID: Oper
- Password: Oper



## 7.2 How to view tank details

The below described operations can be performed with the default user access rights for an operator ("User access rights", → 13).

The **General Details** tab displays the most important tank data dynamically.

### To view the General Details tab

1. On the **Tank Details** screen, click the **Tank Details** tab. Tankvision displays the screen as follows:

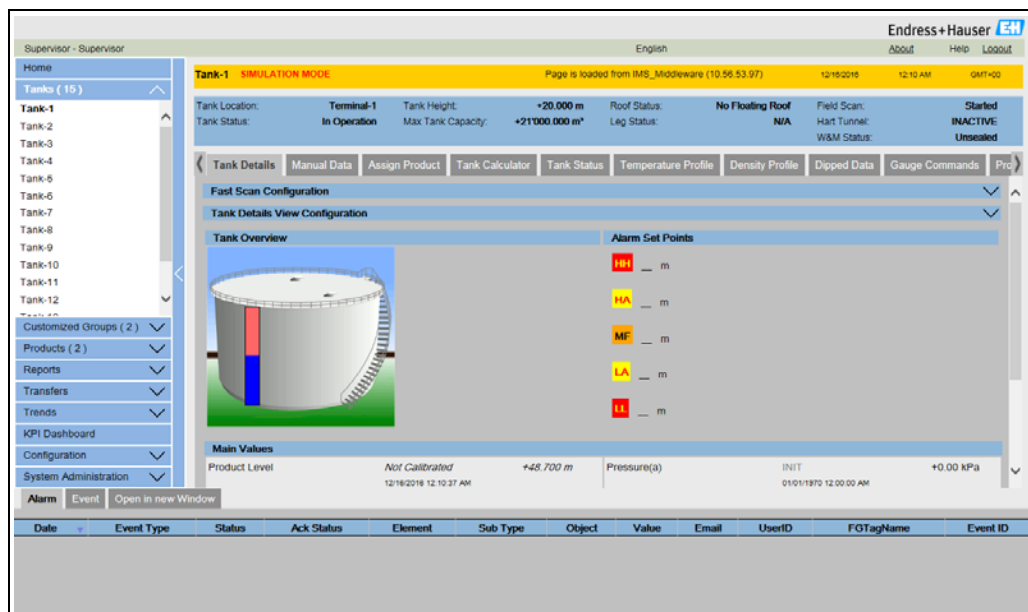

NXA82x\_Tank\_General-Details-Tab

Column	Description
Tank Overview	This area displays the picture of the tank.
Alarm Set Points	This area displays the corresponding Alarm Set Points for that particular tank.
Main Values	<p>This area displays the measured and calculated values of the product or tank parameters in terms of temperature, pressure, density and water level along with their respective units of measurement, depending on the configuration made in <b>Tank Details View Configuration</b> (see BA00339G). The date and time at which the value of each parameter has changed is also displayed along with the measured value status:</p> <ul style="list-style-type: none"> <li>■ OK OK Status</li> <li>■ INIT Field Scan started, value not yet received and processed</li> <li>■ MANUAL Value set to manual</li> <li>■ NODATA Calculation not configured, Field Scan is off</li> <li>■ INVALIDDATA Calculation is out of boundaries</li> <li>■ LASTVALIDVALUE Value is set on HOLD, need additional servo configuration</li> <li>■ FAIL Communication error on field protocol of device configuration</li> <li>■ NOT CALIBRATED Value is not calibrated</li> </ul>

---

Column	Description
Secondary Values	This area displays the measured and calculated values of the product parameters in terms of volume, tank capacity, reference density, floating roof adjustment, product and vapor mass along with their respective units of measurement and status. Which values are displayed, depends on the configuration made in <b>Tank Details View Configuration</b> (see BA00339G).
Tank & Product Configuration	This area displays the tank and product configuration data used for calculation.

## 7.2.1 Error and Status codes Modbus communication

### Gauge Error NMS5

Error Code	Description	Definition	Remarks
0	No error	No error present	
101	OVER TENSION	Measured displacer weight exceeds the Over Tension set value at GVH 162	
102	UNDER TENSION	Measured displacer weight reduced below the Under Tension set value at GVH 163	
106	Z PHASE NO INPUT (2nd)	Unable to recognize Z phase pulse (1 complete rotation of encoder) to CPU after retry	
107	ADC/SENSOR ERROR	Signal from AD converter out of the range	
111	LOCAL ERROR NMT	Recognize device error at the Prothermo NMT 53x (Average Temperature)	*2
112	Z PHASE NO INPUT (1st)	Unable to recognize Z phase pulse (1 complete rotation of encoder) to CPU	
113	LOCAL ERROR NRF	Recognized device error at the Promonitor NRF560	*3
114	SIFA ERROR	Local HART master IC failure on the Proservo	
115	WIRE CALIB. ERROR	Excess auto wire calibration range (e.g. build up on the wire)	
120	DISPLACER CALIB. ERROR	Excess auto weight calibration range (e.g. deposit and build up on the displacer)	
121	LCD CHECK	Recognized error between display panel 3 keys control input to CPU	
122	A PHASE NO INPUT	Unable to recognize a phase pulse (20 pulse / 1 rotation of encoder) to CPU	
124	POWER FAILURE	Supply voltage drop below allowable value	
201	MEMORY ERROR	Memory defect in W&M parameters	
232	LOCAL ERROR DEVICE1	Recognized device error at connected HART device 1	*3
233	LOCAL ERROR DEVICE 2	Recognized device error at connected HART device 2	*3
240	DEVICE ERROR NRF	Local HART communication error to the Promonitor NRF560	*3
250	DEVICE ERROR NMT	Local HART communication error to the Prothermo NMT53x	*2
130	DEVICE ERROR: DEVICE1	Local HART communication error to the HART device 1	*3
131	DEVICE ERROR: DEVICE2	Local HART communication error to the HART device 2	*3
132	ROM ERROR	Failure in the EEPROM data	
133	ECONOUCE CONTACT ON	Status input activated via connected switch (e.g. Leak detector, level alarm switch)	

#### Remarks

\*2 Error code available only when the Prothermo NMT53x or 3 wire RTD SPOT temperature bulb is connected.

\*3 Error code available only when the Promonitor NRF560 or HART device 1/2 is connected.

## Gauge Status NMS5

Error Code	Description	Remarks
0	No definition	
1	Displacer at reference position	
2	Displacer hoisting up	
3	None	
4	Displacer stop	
5	Level measurement, balanced	
6	Up. I/F level, balanced	*1
7	Mid. I/F level, balanced	*1
8	Bottom meas. balanced	*1
9	Upper Dens, finished	*1
10	Middle Dens, finished	*1
11	Bottom Dens, finished	*1
12	Release over tension	
13	Calibration activated	
14	Seek level	
15	Follow level	
16	Seek Upper Density	*1
17	Seek Middle Density	*1
18	Seek Density Bottom	*1
19	Seek Upper I/F level	*1
20	Follow up. I/F level	*1
21	Seek Mid. I/F level	*1
22	Follow Mid. I/F level	*1
23	Seek Bottom Level	
24	Not initialised	
25	Stopped at High Stop.	
26	Stopped at Low Stop	
27	Repeatability testing	
28	Seeking water level	*1
29	Water level, balanced	*1
30	Follow water level	*1
31	Over/Under Tension	

*Remarks*

\*1 Status available when the Proservo NMS53x is implemented with Interface and Density measurement functionality.

For NRF590 neither status codes nor error codes are available the Gauge Error/Gauge Status are set to 0 with the status INIT to show that the data are invalid.

## 7.2.2 Error and Status codes V1

### Error codes NMS5

Error Code	Description
0	No Error
1	Over Tension
2	Under Tension
3	Encoder Error
4	Hall Sensor Error

### Status codes NMS5

Status Code	Operation Status
01	Up
02	Stop
03	Bottom
04	Upper Density
05	Level
08	Upper Interface Level
09	Release Over Tension
10	Middle Density
11	Density Bottom
12	Middle Interface Level
13	Calibration Active
27	Repeatability Testing
28	Water Dipping

### 7.2.3 Status Codes WM550

With WM550 the status are transferred bit coded. In Tankvision this bit sequence is shown as decimal number which needs to be transferred into bits to be interpreted.<sup>1)</sup>

Gauge Error Bits		Gauge Status Bits	
0	Servo Check	0	Gauge Servoing
1	Seeking Level	1	Gauge Stowed
2	Doing Profile	2	Stow received on port 1
3	Doing Dip	3	Stow received on port 2
4	Finding BSW	4	NOVRAM corrupted
5	Following BSW	5	Multielement therm. Fitted
6	Finding Datum	6	Ref. Voltage is DN
7	Following Level	7	Calibration bit 0
8	Density Sensor	8	Calibration bit 1
9	Temp. Sensor	9	Calibration bit 2
10	BSW Sensor	10	-
11	Datum Sensor	11	-
12	Conf. Warning	12	-
13	Liquid State	13	-
14	Liquid State Unknown	14	-
15	ISH Fitted	15	-

### Gauge Error from NRF590 and NMS5

Tank Side Monitor NRF590 (Task 2, 3, 4, 5, 9, 11, 27, 28, 30, 31, 36, 37, 38)

Decimal	Bit Coded	Description
0	0000'0000'0000'0000	Level
1	0000'0000'0000'0001	Stop

Proservo NMS5 (Task 2, 3, 4, 5, 9, 11, 27, 28, 30, 31)

Decimal	Bit Coded	Description
0	0000'0000'0000'0000	Level
1	0000'0000'0000'0001	Stop

1) To translate the decimal number in the gauge staus/gauge error field into binary number you can use the following formular in Excel (change A1 to the field the decimal number is written):  

$$=RIGHT(SUMPRODUCT(INT(MOD(A1/2^(ROW(16:30)-1),2))*10^(ROW(1:15)-1))&TEXT(SUMPRODUCT(INT(MOD(A1/2^(ROW(1:15)-1),2))*10^(ROW(1:15)-1)),REPT("0",15)),INT(LN(A1)/LN(2))+1)$$

## Proservo NMS5 (Task 36, 37, 38)

Decimal	Bit Coded	Description
16386	0100'0000'0000'0010	Level unbalanced or seeking level
16388	0100'0000'0000'0100	Upper density or density seeking
16400	0100'0000'0001'0000	Upper interface level (unbalanced) or upper interface seeking
16416	0100'0000'0010'0000	Upper interface level (balanced) or upper interface following
16448	0100'0000'0100'0000	Bottom level, Bottom Density seeking or Bottom seeking
16512	0100'0000'1000'0000	Level or Level following
49154	1100'0000'0000'0010	Level unbalanced or seeking level, compatibility mode
49156	1100'0000'0000'0100	Upper density or density seeking, compatibility mode
49168	1100'0000'0001'0000	Upper interface level (unbalanced) or upper interface seeking, compatibility mode
49184	1100'0000'0010'0000	Upper interface level (balanced) or upper interface following, compatibility mode
49216	1100'0000'0100'0000	Bottom level, Bottom Density seeking or Bottom seeking, compatibility mode
49280	1100'0000'1000'0000	Level or Level following, compatibilty mode

## Gauge Error from NRF590 and NMS5

### Status report (Task 1) NRF590

Decimal	Bit Coded	Description
0	0000'0000'0000'0000	No multi element temperature fitted
32	0000'0000'0010'0000	Multe element temperature fitted

### Status report (Task 1) NMS5

Decimal	Bit Coded	Description
1	0000'0000'0000'0001	Gauge Servoing
5	0000'0000'0000'0101	Stow received on port 1
7	0000'0000'0000'0111	Stow received on port 1, Gauge Stowed
9	0000'0000'0000'1001	Stow received on port 2
11	0000'0000'0000'1011	Stow received on port 2, Gauge Stowed
21	0000'0000'0001'0101	NMS Error Code present (see below), Stow received on port 1
23	0000'0000'0001'0111	NMS Error Code present (see below), Stow received on port 1, Gauge Stowed
25	0000'0000'0001'1001	NMS Error Code present (see below), Stow received on port 2
27	0000'0000'0001'1011	NMS Error Code present (see below), Stow received on port 2, Gauge Stowed
33	0000'0000'0010'0001	NMT connected, Gauge Servoing
37	0000'0000'0010'0101	NMT connected, Stow received on port 1
39	0000'0000'0010'0111	NMT connected, Stow received on port 1, Gauge Stowed
41	0000'0000'0010'1001	NMT connected, Stow received on port 2
43	0000'0000'0010'1011	NMT connected, Stow received on port 2, Gauge Stowed
53	0000'0000'0011'0101	NMS Error Code present (see below), NMT connected, Stow received on port 1
55	0000'0000'0011'0111	NMS Error Code present (see below), NMT connected, Stow received on port 1, Gauge Stowed
57	0000'0000'0011'1001	NMS Error Code present (see below), NMT connected, Stow received on port 2
59	0000'0000'0011'1011	NMS Error Code present (see below), NMT connected, Stow received on port 2, Gauge Stowed

### NMS Error Codes

Error Code	Description
101	Over Tension
102	Under Tension
106	Z Phase no Input (2)
107	ADC Sensor Error
112	Z Phase no Input
115	Wire calibration error
120	Displacer calibration error
122	A Phase no input



### 7.2.4 WM550 Task-51

The WM550 protocol offers only a limited value resolution and therefore an additional Task-51 has been added to the WM550 protocol for the Tank Side Monitor NRF590. This Task-51 can be added to the foreground task in gauge map file as shown below:

```
<?xml version="1.0"?>
<Tankvision>
  <Tankvision_WM550_PARAM_MAP>
    <FOREGROUND>TASK_51</FOREGROUND>
  </Tankvision_WM550_PARAM_MAP>
</Tankvision>
```

NXA82x\_WM550\_Task51

The Task-51 delivers a predefined set of information which is described in the table below.

Measured Value	Tank Parameter	Granularity	Units
Level	Product Level	1	mm
BSW	Water Level	1	mm
Temperature	Product Temperature	0.1	°C
Temperature	Vapor Temperature	0.1	°C
Pressure	P1(Bottom) Pressure	0.01	bar
Pressure	P2(Middle) Pressure	0.01	bar
Pressure	P3 (Top) Pressure	0.01	bar
Density	Observed Density	0.1	kg/m3

## 7.3 How to view Temperature Profiles

The below described operations can be performed with the default user access rights for an operator ("User access rights", → 13).

The **Temperature Profile** tab displays measured values from the spot elements of an average temperature probe, if configured.

 Depending on the system architecture this parameters might be used for displaying other values than temperatures.

### To view the Temperature Profile tab

1. On the **Tank Details** screen, click the **Temperature Profile** tab. Tankvision displays the screen as follows:

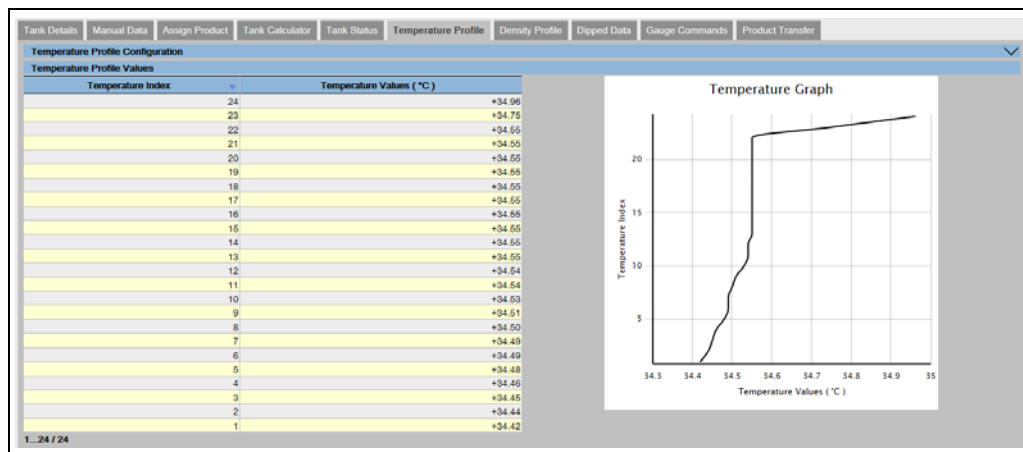

Temperature\_Profile

The table presents the temperature profile data according to the corresponding **Temperature Index** (element number, where the lowest element is the element number 1). This information is also presented graphically next to this table in the **Temperature Graph**. The amount of elements to be displayed (according to the average temperature probe which is in use) can be selected in the **Temperature Profile Configuration** section.

## 7.4 How to view Density Profiles

The below described operations can be performed with the default user access rights for an operator ("User access rights", → 13).

The **Density Profile** tab displays measured values from the spot elements of an average density probe, if configured.

 Depending on the system architecture this parameters might be used for displaying other values than densities.

### To view the Density Profile tab

1. On the **Tank Details** screen, click the **Density Profile** tab. Tankvision displays the screen as follows:

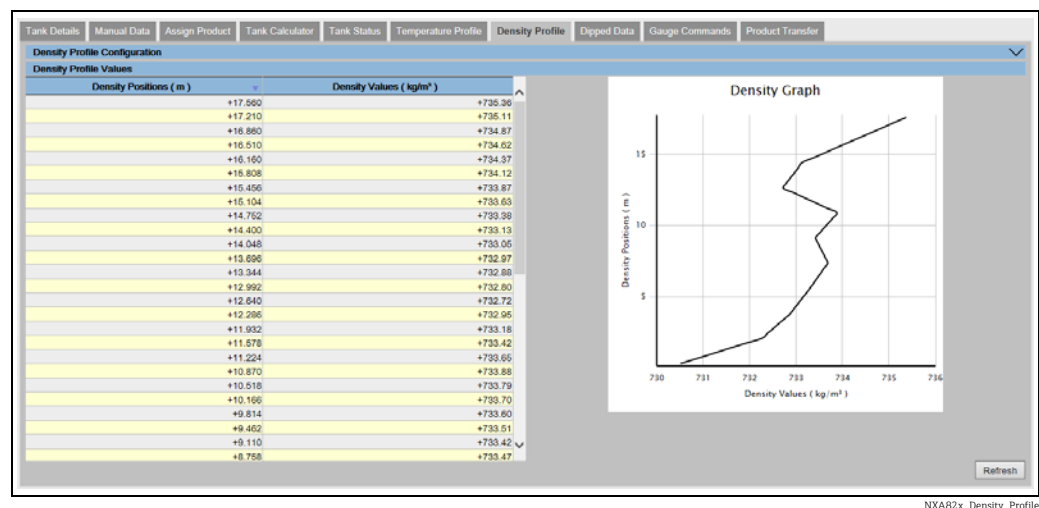

NXA62x\_Density\_Profile

The table presents the density profile data according to the corresponding **Density Positions**. This information is also presented graphically next to this table in the **Density Graph**.

The amount of elements to be displayed (according to the average density probe which is in use) can be selected in the **Density Profile Configuration** section.

## 7.5 How to view and enter Manual Data

The below described operations can be performed with the default user access rights for an operator ("User access rights", → 13). The **Manual Data** tab gives you the option of entering values for the product level, temperature, density and pressure manually.

 Functionality is depending on the user right settings.

### Selection of Parameters for manual data entry

1. Click the **Manual Data** tab. With opening the **Set/Configure Manual Parameters** the following screen for selecting parameters for manual data entry is shown.

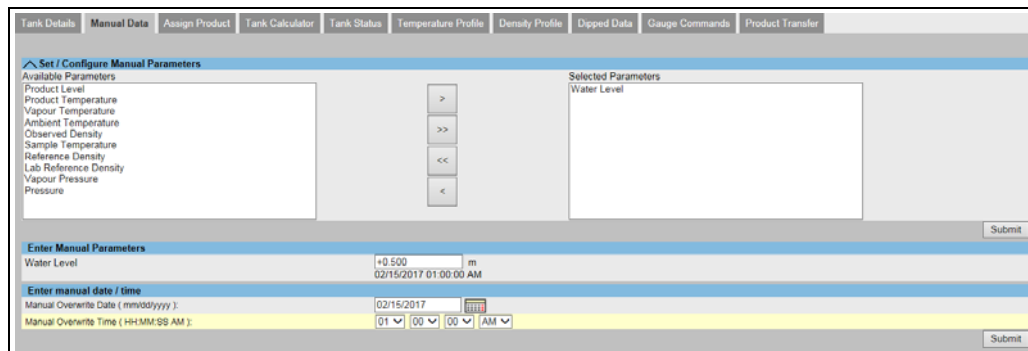

NXA82x\_Manual-Data\_Set-Configure-Manual-Parameters

2. The user can select one or several parameter from the available parameter list and move them to the selected parameter list by using > button and clicking **Submit**. Using >> moves all available parameters in the selected Parameters (deselecting works in accordance by using the < or << buttons). From the following list the parameters can be chosen (see below):

Field	Description
Product level	Enter the appropriate value for the product level in the according text box. The data type for this field is numeric.
Water level	Enter the appropriate value for the water level in the according text box. The data type for this field is numeric.
Product Temperature	Enter the appropriate value for the product temperature in the according text box. This field displays the temperature of the product in the tank. The data type for this field is numeric.
Vapor Temperature	Enter the appropriate value for the vapor temperature in the according text box. This field displays the temperature of the vapor in the tank. The data type for this field is numeric.
Ambient Temperature	Enter the appropriate value for the ambient temperature in the according text box. This field displays the ambient temperature outside the tank. The data type for this field is numeric.
Observed Density	Enter the appropriate value for the observed density in the according text box. This field displays the observed density of the product in the tank. The data type for this field is numeric.
Sample Temperature	Enter the temperature at which the density of the sample was measured in the according text box. This field displays the temperature of the density sample. The data type for this field is numeric.
Reference Density	Enter the appropriate value for the reference density in the according text box. This field displays the reference density of the product in the tank. The data type for this field is numeric.

Field	Description
Vapor Pressure	Enter the appropriate value for the vapor pressure in the according text box. This field displays the vapor pressure of the product in the tank. The data type for this field is numeric. In the radio buttons below mark the pressure measurement method: <b>absolute</b> or <b>relative</b> .
Pressure	Enter the appropriate value for the pressure in the according text box. This field displays the pressure of the product in the tank. The data type for this field is numeric. In the radio buttons below mark the pressure measurement method: <b>absolute</b> or <b>relative</b> .

3. Tankvision will show a confirmation message and the parameters are now available to enter manual values.

### To enter manual data

1. Click the **Manual Data** tab. Tankvision displays the screen as follows:

The screenshot shows the 'Manual Data' configuration interface. It includes a navigation bar with tabs: Tank Details, Manual Data (selected), Assign Product, Tank Calculator, Tank Status, Temperature Profile, Density Profile, Dipped Data, Gauge Commands, and Product Transfer. The main content area is titled 'Set / Configure Manual Parameters' and contains the following fields:

- Enter Manual Parameters:**
  - Product Level: +54.600 m
  - Product Temperature: +13.5 °C
  - Vapour Temperature: +0.0 °C
- Enter manual date / time:**
  - Manual Overwrite Date (mm/dd/yyyy): 12/16/2016
  - Manual Overwrite Time (HH:MM:SS AM): 01:00:00 AM

A 'Submit' button is located at the bottom right of the form.

NXA82x\_Manual-Data\_Enter-Manual-Parameters

Column	Description
Parameter Name	This column displays a list of the tank parameters that can be configured manually.
Manual Gauge Value	This column displays the text boxes that allow the user to enter the data for the relevant parameter.

2. Enter the appropriate information in the relevant fields.
  3. Click the **Submit** button.
  4. After saving the settings, Tankvision displays a confirmation message.
-  An event is generated after manually entering a value for a tank parameter. The event details can be viewed in the **Event** overview.

## 7.6 How to enter dipped data

The below described operations can be performed with the default user access rights for an operator ("User access rights", → 13).

The **Dipped Data** tap gives you the option of entering dipped values for the product level, water level, product temperature, observed density with acc. sample temperature and the reference density.

Field	Description
Product level	Enter dipped values for the product level. Activate the field by enabling the check box in the beginning of the column.
Water level	Enter dipped values for the water level. Activate the field by enabling the check box in the beginning of the column.
Product temperature	Enter dipped values for the product temperature. Activate the field by enabling the check box in the beginning of the column.
Date and Time	Enter the appropriate Date and Time in the text box / drop down list. This time will be used as time stamp for the manually entered value. The data type for this field is time.

## 7.7 How to issue gauge commands

The below described operations can be performed with the default user access rights for an operator ("User access rights", → 13).

Every gauge supports a specific set of commands. The Tankvision system supports these gauges and stores their data and corresponding gauge commands in "gauge definition files". The functionality of gauge commands is dependent on the gauge type assigned to the tank, whereas completion of a gauge command is based on the gauge status or gauge commands status. The Tankvision system retrieves these commands from the "gauge definition files" during the configuration of gauge commands. Gauge commands can be scheduled and sent only by an authorized user. Most of these commands are unique for servo gauges. You can send a gauge command to a gauge installed on a tank manually or even schedule a gauge command to be sent automatically.

Tankvision Tank Scanner prevents the user to send the same gauge command multiple times to a servo gauge (i.e. the Tank Scanner only sends gauge command once to the servo gauge and ignores the gauge command until a new command is requested). This applies for gauge command requests via the Host Link, OPC DA or the web interface.

In case a gauge command has been given to the servo gauge via a separate way (e.g. directly from the display), then the Tank Scanner will not get this information. In this case simply by sending a different gauge command and switching back to the gauge command will solve the issue.

### 7.7.1 Schedule Gauge Command

The Tankvision system allows the user to schedule gauge commands, such that they can be executed either immediately or at a certain time. An operator can schedule a gauge command only if that particular gauge command is enabled in the **Gauge Command** configuration screen.

**To schedule a gauge command**

1. Click the **Gauge Commands** tab. Tankvision displays the screen as follows:

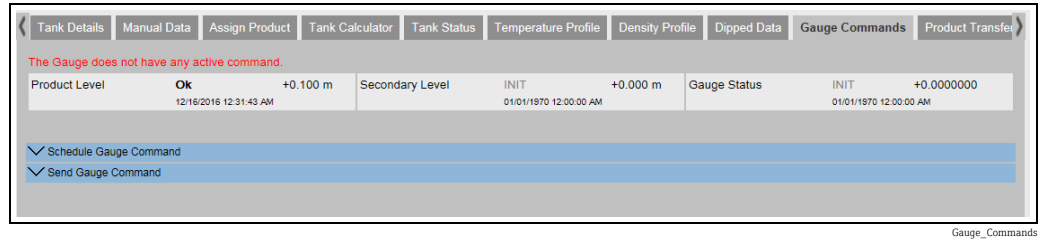

Gauge\_Commands

2. Click  on **Schedule Gauge Command**. Tankvision displays the screen as follows:

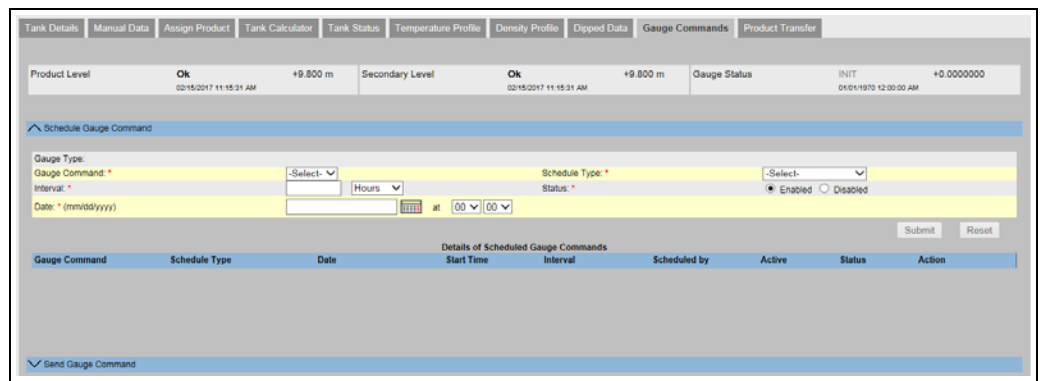

NXA82x\_Tank\_Gauge-Commands-Tab

Field	Description
Gauge Type	This field displays the Gauge Type.
Gauge Command	Select the appropriate gauge command from the drop down list. The data type for this field is "character".
Schedule Type	Select the appropriate Schedule type from the drop down list. The gauge command can be scheduled to be sent once or scheduled for automatic repetition. <b>Sent Once:</b> Select <b>sent once</b> to enable the gauge command to be sent only once. <b>Automatic Repetition:</b> Select <b>automatic repetition</b> to enable the Interval field. This field allows you to schedule the system to send a particular gauge command periodically. The data type for this field is "character".
Interval	Enter the appropriate interval in the text box. This field is enabled if the Schedule Type for the gauge command is selected as <b>Automatic Repetition</b> . The data type for this field is "numeric". Also, in the adjacent text box: Select the appropriate unit for the interval from the drop down list. The system allows you to schedule the interval for the gauge commands in terms of hours or minutes. The data type for this field is character.
Date	Enter or select the appropriate date from the drop down calendar. The Tankvision system allows you to select the date on which the gauge command is to be sent. The data type for this field is alphanumeric. Also, enter or select the appropriate time in terms of hours and minutes from the respective drop down lists. The Tankvision system allows you to select the exact time at which the gauge command is to be sent. If the Schedule Type for a gauge command is "automatic repetition", then the time entered in the text boxes indicates the first time the gauge command is to be sent. The data type for this field is numeric.
Status	Select the appropriate option. This field indicates the status of the gauge command. This field allows you to enable or disable a gauge command.

3. Enter the appropriate information in the relevant fields.

4. Click the **Submit** button to send a gauge command, or click the **Reset** button to exit.
  5. After saving the settings, Tankvision displays a confirmation message.
-  The system generates an event, when the Gauge Command is sent. This information can be viewed in the **Event** tab.

#### Error Messages

1. "Cannot send gauge command while tank status is Manual, In Maintenance, or Locked." This message appears when the user sends a gauge command while tank status is **Manual, In Maintenance or Locked**.

### 7.7.2 Send Gauge Command

The Tankvision system allows you to send commands to a gauge installed on a tank. A gauge command can be sent only if that particular command is enabled for the tank in the **Gauge Command** configuration screen. Once a gauge command is sent, it remains active till the system receives an appropriate response from the gauge. The response for a gauge command depends on the gauge and communication protocol.

The Tankvision system allows the user to send gauge commands via following interfaces:

1. Via Tankvision Tankscanner web interface
2. Via connected Host application with NXA822
3. Via OPC Server

#### To send a gauge command

1. Click the **Gauge Commands** tab. Tankvision displays the screen as follows:

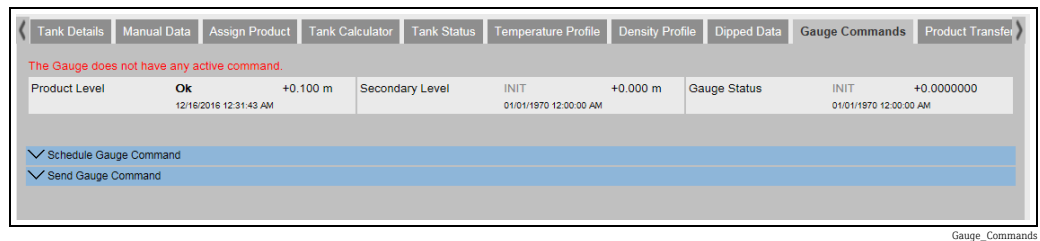

Gauge\_Commands

2. Click  on **Send Gauge Command**. Tankvision displays the screen as follows:

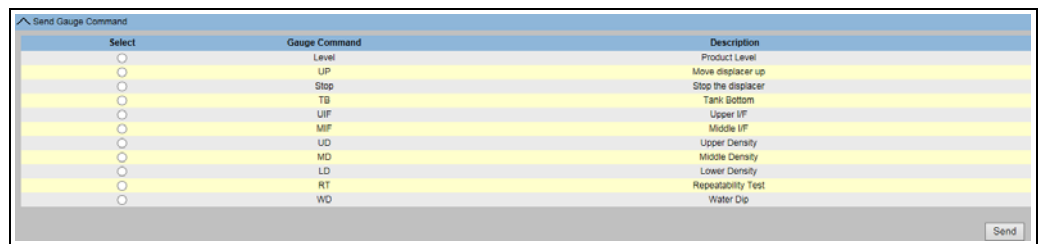

NXA82x\_Gauge-Commands\_Send-Gauge-Command

Field	Description
Product level	Displaying Product Level and Product Temperature incl. Status
Product temperature	
Status	Displaying Active Gauge Command and issuing Date and Time
Date and Time	

Column	Description
Select	Select the appropriate gauge command option corresponding to the gauge command name. The radio buttons are highlighted only if the corresponding gauge commands are configured in the <b>Gauge Command</b> screen.
Gauge Command	This column displays a list of gauge commands in abbreviated form.
Description	This column displays a short description corresponding to each gauge command.

3. Select the appropriate gauge command option.
4. Click the **Send** button to activate the gauge command.
5. After saving the settings, Tankvision displays a confirmation message as follows:



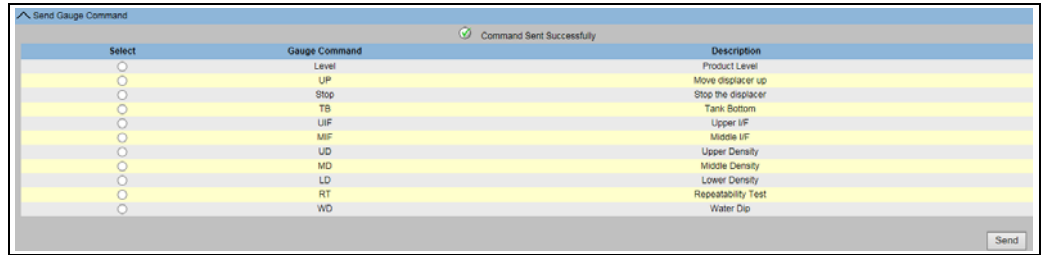

NXA82x\_Gauge-Commands\_Send-Gauge-Command\_Successfully

6. In the above figure, all options in the **Select** column are disabled, except the **Stop** option. If the gauge command has to be stopped, then select the stop option, and click the **Send** button.  
If another gauge command needs to be sent, it might be necessary to cancel the active command by sending the STOP command prior issuing the new command.

 The system generates an event, when a Gauge Command is activated. This information can be viewed in the **Event** tab.

**Error Messages**

1. "Cannot send gauge command while tank status is Manual, In Maintenance, or Locked." This message appears when the user sends a gauge command while the tank status is **Manual, In Maintenance** or **Locked**.

## 7.8 How to view a real time trend

The below described operations can be performed with the default user access rights for an operator ("User access rights", → 13).

The Tankvision system collects data from the tanks and monitors these values using a trend. A trend is a line graph which gives a pictorial representation of the recent changes of the measured values over time. The Real Time Trend is hosted in the Tankvision unit. It depicts the real-time measured or calculated values of a selected tank as a function of time in the form of a line chart.

The system has default settings which can be customized as required for each tank element and will eventually be plotted on the trend. Up to 4 values can be plotted in one chart.

### To view a real time trend

1. In the navigation tree, click the **Trends** header. Click **Real Time trend**. Tankvision displays the screen as follows:

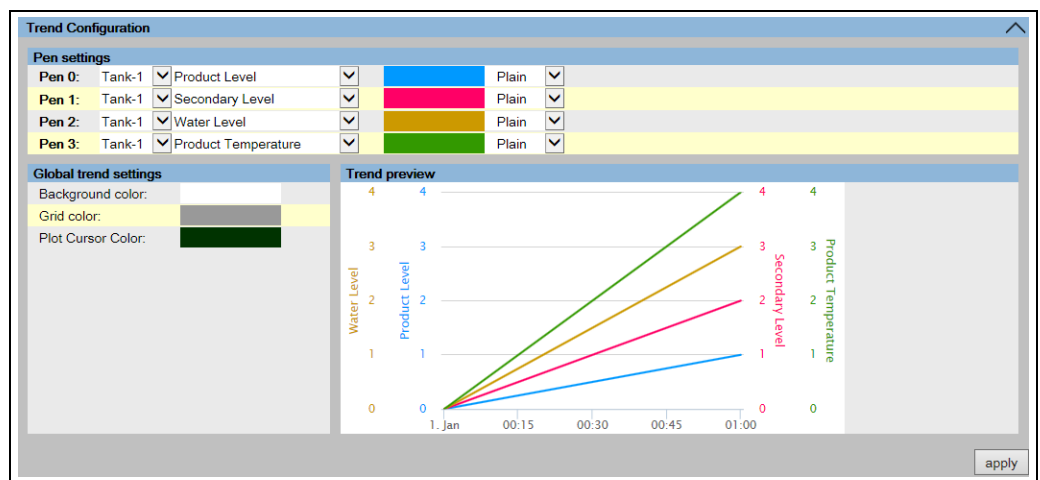

Section	Description
Pen settings	This section displays a list of pens (Pen 0, Pen 1, Pen 2 and Pen 3) that are used to identify the parameters selected. Select the appropriate tanks, parameters, pen colors and pen style from the respective drop down lists.
Global trend settings	Select the Background color, Grid color and Plot Cursor color from the respective drop down lists.
Trend preview	See a preview of the real time trend plot with the currently selected settings.

2. Select the appropriate settings and click the **apply** button. Tankvision displays the screen as follows:



NXA82x\_Trends\_Real-Time-Trends\_Trend-Configuration

The line graphs are displayed based on the selection of tank parameters in the Trend Configuration area.





A plotter can be moved through the graphic area. According to the position of the plotter values are displayed in a field next to it. For example:



NXA82x\_Trends\_Real-Time-Trends\_Trend-Configuration\_Plotter

Click and drag with the mouse to zoom into the graph.

Field	Description
Period	The Period icons allow you to make changes to the current time window. The selected period (last 6 hours, 3 hours, 90, 60, 30, 15, 10, 5 minutes or the last minute) is displayed in the plotting area.
print chart	The <b>print chart</b> icon lets you print the current real time trend chart with a connected printer.

Field	Description
Pan	<p>The Pan icons allow you to make changes in the current time window displayed in trend.</p> <p> The <b>Go First</b> button rewinds the trend to the oldest available values in the rolling data buffer of the trend.</p> <p> The <b>Go Previous</b> button shows the previous time window.</p> <p> The <b>Go Next</b> button shows the next time window.</p> <p> The <b>Go Last</b> button shows current or latest values in the trend.</p>
run/stop	<p>The run/stop icon lets you run or stop the real time trend. When the trend is running, <b>run</b> is displayed. When the trend is stopped, <b>stop</b> is displayed.</p>

## 7.9 How to assign/change products at a tank

The below described operations can be performed with the default user access rights for an operator ("User access rights", →  13).



After configuring a product, it has to be assigned to a tank. The user can assign only one product to a tank. A product which is currently assigned to a tank can not be deleted from the system.

### To assign a product to a tank

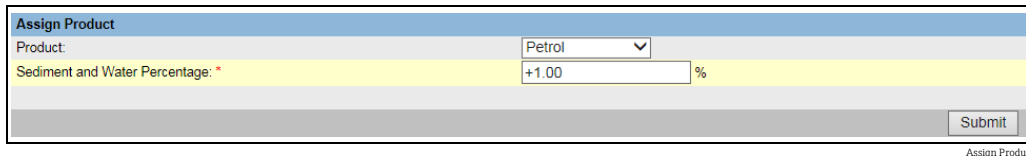
1. Click the **Assign Product** tab. Tankvision displays the screen as follows:



Field	Description
Product	Select the appropriate product from the drop down list. This field enables the system to assign a product to a specific tank.
Sediment and Water Percentage	Enter the appropriate sediment and water percentage for the selected product. The Tankvision system uses the sediment and water percentage in tank inventory calculations and corrects the product volume according to the sediment and water content. The data type for this field is numeric.

2. Enter the appropriate information in the relevant fields.
  3. Click the **Submit** button to assign the product to the tank.
  4. After saving the settings, Tankvision displays a confirmation message.
-  Once the product is assigned to the tank, the tank is automatically added to the built-in product group, and the tank can be seen in the navigation tree of the screen under the **Products** Header.
  -  An event is generated after a product is assigned to a tank. The event details can be viewed in the **Event** overview.

## 7.10 How to do Product transfer

The below described operations can be performed with the default user access rights for an operator ("User access rights", → 13).

The product transfer is a day-to-day tank farm operation. During the tank farm operation, a product is pumped into or out of a tank. A tank may receive product from a pipeline, tanker, ship or another tank. When the product is to be filled into a tank, it is necessary to check the available tank capacity. Similarly, when the product is to be pumped out of a tank, it is necessary to check the product volume in the tank. Tankvision allows an operator to create a new product transfer.

Tankvision does not control the product transfer, but it monitors product transfers and generates product transfer data and reports. When a company sells the product stored in tanks to another company, it is important that the tank is W&M (weights and measurement) certified for correct measurements. The Tankvision system provides this facility by calibrating the system and then gets it W&M approved. All tanks which are W&M certified can be used for custody transfers.

In this case the product transfer report (→ 44) will mention the W&M approved status, which can be used to prove that the correct amount of product has been transferred.

### 7.10.1 Product Transfer Life Cycle

The Tankvision system allows the user to create, finish or abort a product transfer. Once a product transfer is created, the system monitors the product transfer to detect "start of transfer (active)", "product transfer paused" or "product transfer completed".

#### The life cycle of a product transfer

The product transfer traverses through its life cycle as follows:

- Create a product transfer for a tank
- Detection of the start of the product transfer
- Detection of a paused transfer
- Detection of a completed transfer
- Transfer finished or aborted
- Product transfer report

#### To transfer a product for a tank

1. Click the **Product Transfer** tab. Tankvision displays the screen as follows:

Product Transfer Configuration							
Source/Destination:				Source			
Transfer Type *				In	▼		
Batch Mode *				Volume	▼		
Batch Size *				95	%		
Minimum Batch Deviation Percentage *				105	%		
Maximum Batch Deviation Percentage *				80	%		
Pre Alarm Percentage *							
Comments:							
E-Mail Addresses:							
Submit							
Product Transfer Overview							
Product Level	OK	+0.800 m	Total Observed Volume	OK	+80.000 m³	Product Mass	NODATA
Gross Observed Volume	OK	+80.000 m³	Gross Standard Volume	NODATA	+80.000 m³	Net Standard Volume	NODATA
Flow Direction		0.0	Batch Size(Volume)		0.0	Batch Size(Mass)	0.0
TOV Flow Rate		0.0	Mass Flow Rate		0.0	Transferred Volume	0.0
Transferred Mass		0.0	Time To Complete		0.0	Transfer Status	INIT NONE

Product\_Transfer\_red

Field	Description
Source/Destination	The system displays the status of inflow or outflow of the product. If the transfer type is <b>In</b> , then this field displays <b>Source</b> . If the transfer type is <b>Out</b> , then this field displays <b>Destination</b> .

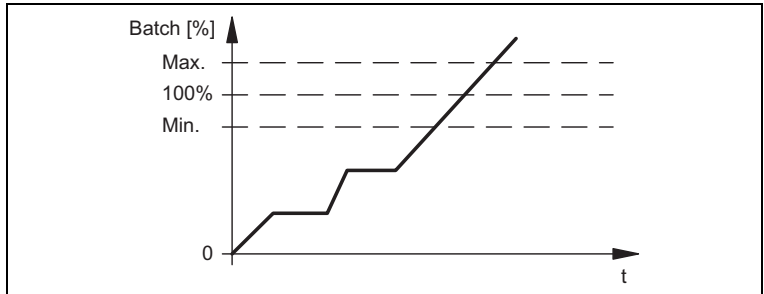
Field	Description		
Transfer Type	<p>Select the appropriate product transfer type from the drop down list. This field enables the system to allow transfer of the product into or out of the tank depending on the selected option, viz., <b>In</b> or <b>Out</b>.</p> <p><b>In:</b> A product is being filled into a tank.  <b>Out:</b> A product is being pumped out from a tank.                      This field is disabled after creating a new product transfer.</p>		
Batch Mode	<p>Select the appropriate batch mode from the drop down list. This field allows you to select the mode of product transfer. The batch mode is <b>Volume</b> or <b>Mass</b>.</p> <p><b>Volume:</b> The quantity of product to be transferred is specified as Total Observed Volume (TOV) of product.  <b>Mass:</b> The quantity of product to be transferred is specified as product Mass.                      This field is disabled after creating a new product transfer.</p>		
Batch Size	<p>Enter the appropriate batch size in the text box. This field displays the quantity of the product that is being transferred. The unit depends on whether the mode of product transfer is in volume or mass. The data type for this field is numeric.</p>		
Batch Deviation Percentage	<table border="0" style="width: 100%;"> <tr> <td style="width: 50%; vertical-align: top;"> <p><b>Minimum</b>                              Enter the minimum batch percentage. This field is used to determine, whether the product transfer is complete or not. The product transfer is considered as completed, if:</p> <ul style="list-style-type: none"> <li>▪ The quantity of product that has been transferred so far (calculated as per batch mode) is equal to or more than the minimum batch deviation percentage of the batch size, and ...</li> </ul> </td> <td style="width: 50%; vertical-align: top;"> <p><b>Maximum</b>                              Enter the maximum batch percentage. This field is used to determine, whether the product transfer is complete or not. The product transfer is considered as completed, if:</p> <ul style="list-style-type: none"> <li>▪ If the batch exceeds the max. batch percentage an event is generated.</li> <li>▪ The quantity of product that has been transferred so far (calculated as per batch mode) is equal to or more than the minimum batch deviation percentage of the batch size and is less than the maximum batch deviation percentage of the batch size; and ...</li> </ul> </td> </tr> </table> <p>▪ ... the rate of change of volume is less than the minimum rate of change of the volume                      The data type for this field is numeric.</p> <div style="text-align: center;">  </div>	<p><b>Minimum</b>                              Enter the minimum batch percentage. This field is used to determine, whether the product transfer is complete or not. The product transfer is considered as completed, if:</p> <ul style="list-style-type: none"> <li>▪ The quantity of product that has been transferred so far (calculated as per batch mode) is equal to or more than the minimum batch deviation percentage of the batch size, and ...</li> </ul>	<p><b>Maximum</b>                              Enter the maximum batch percentage. This field is used to determine, whether the product transfer is complete or not. The product transfer is considered as completed, if:</p> <ul style="list-style-type: none"> <li>▪ If the batch exceeds the max. batch percentage an event is generated.</li> <li>▪ The quantity of product that has been transferred so far (calculated as per batch mode) is equal to or more than the minimum batch deviation percentage of the batch size and is less than the maximum batch deviation percentage of the batch size; and ...</li> </ul>
<p><b>Minimum</b>                              Enter the minimum batch percentage. This field is used to determine, whether the product transfer is complete or not. The product transfer is considered as completed, if:</p> <ul style="list-style-type: none"> <li>▪ The quantity of product that has been transferred so far (calculated as per batch mode) is equal to or more than the minimum batch deviation percentage of the batch size, and ...</li> </ul>	<p><b>Maximum</b>                              Enter the maximum batch percentage. This field is used to determine, whether the product transfer is complete or not. The product transfer is considered as completed, if:</p> <ul style="list-style-type: none"> <li>▪ If the batch exceeds the max. batch percentage an event is generated.</li> <li>▪ The quantity of product that has been transferred so far (calculated as per batch mode) is equal to or more than the minimum batch deviation percentage of the batch size and is less than the maximum batch deviation percentage of the batch size; and ...</li> </ul>		
Pre Alarm Percentage	<p>Enter the pre-alarm percentage. If the quantity of product transferred (calculated as per the batch mode) increases above the pre alarm percentage of the batch size for <b>In</b> transfer or decreases below the pre-alarm percentage for <b>Out</b> transfer, then the system raises a pre-alarm.                      The data type for this field is numeric.</p>		
Comments	<p>Enter the appropriate comments in the comments field. This field allows the user to enter comments related to the product transfer. This information is captured in the product transfer report. The data type for this field is characters.</p>		
E-Mail Addresses	<p>Enter the appropriate e-mail addresses. Whenever the product transfer is completed, the system sends a product transfer report by e-mail to the e-mail addresses entered in this field.</p>		
Transfer Status	<p>This field displays the status of the product transfer. The product transfer status can be: "Armed", "Active", "Paused", "Completed", "Finished" or "Aborted".</p> <ul style="list-style-type: none"> <li>▪ "Armed" (Ready to start)</li> <li>▪ "Active" (In progress)</li> <li>▪ "Paused" (On hold)</li> <li>▪ "Completed" (if min. batch dev. percentage is reached 0 and flow goes to 0)</li> <li>▪ "Finished" (tank transfer finished)</li> <li>▪ "Aborted" (stop immediately before finishing)</li> </ul>		

Below the **Product Transfer Configuration**, the **Product Transfer Overview** is displayed.

2. Enter the appropriate information in the relevant fields.
  3. Click the **Submit** button to create a new product transfer.
  4. After saving the settings, Tankvision displays a confirmation message.
- i** An event is generated after creating a product transfer. The event details can be viewed in the **Event** overview.

### 7.10.2 Status of a Product Transfer

#### Create a New Product Transfer

Creating a new product transfer is the first step to be followed after the pre-condition for product transfer is set in the system. While creating a new product transfer, the transfer status of the tank should be "None". The product transfer status "None" means that the tank does not have any product transfer associated with it in the Armed or Active status, and thus a new product transfer can be created. An image of Tankvision displaying the status as "None" is as follows:

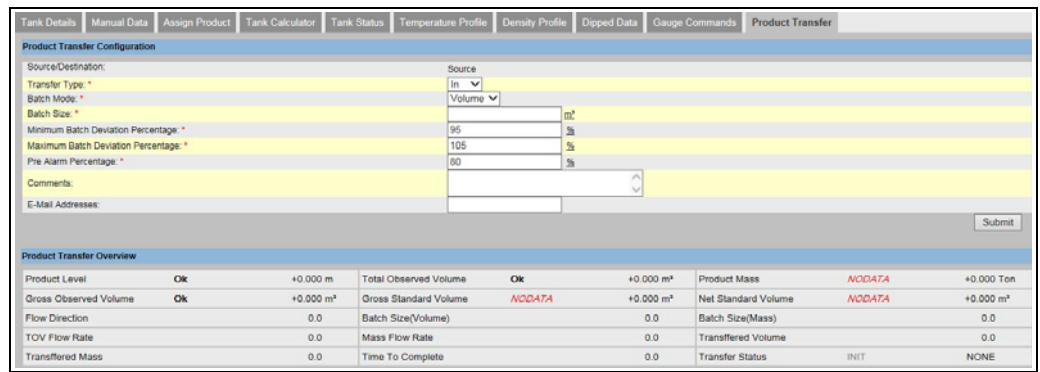

#### Validate product transfer details

Once the user has created a new product transfer for a tank, this tank is said to be "Armed" for product transfer. The system starts monitoring a tank (with status) "Armed" to automatically detect the start of the product transfer. Auto detection of start of Product transfer defined in. Once a tank is armed for a product transfer, no other product transfer can be created for the tank, unless the existing transfer is cancelled.

An image of Tankvision displaying the status as "Armed" is as follows:

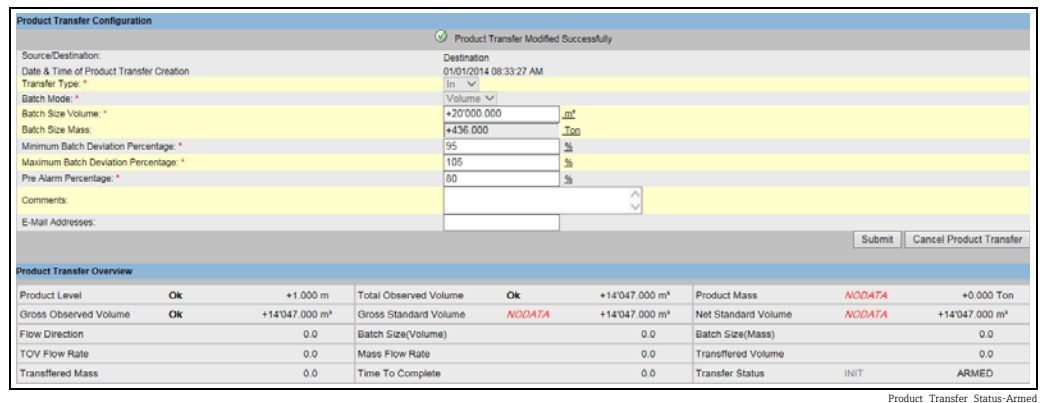

**i** The system generates an event when the status is changed from "None" to "Armed". This information can be viewed in the **Event** tab.



### Detection of the start of a product transfer

Once the product transfer has been armed, the system detects the start of the product transfer based on a change in the level and the rate of change of the level. The system treats the product transfer as started and the product transfer status is changed to "Active" if:

- The change in product level is greater than the minimum level change, and
- The rate of change of level is greater than the minimum rate of change of level configured under the flow calculation details

Once a tank is in the "Active" status for a product transfer, no other product transfer can be created for the tank, unless the active transfer is Finished or Aborted.

An image of Tankvision displaying the status as "Active" is as follows:

The screenshot shows the 'Product Transfer Configuration' window with the following details:

- Source/Destination: [Empty]
- Date & Time of Product Transfer Creation: 01/01/2014 08:33:27 AM
- Transfer Type: [Empty]
- Batch Mode: Volume
- Batch Size Volume: +20'000.000 m³
- Batch Size Mass: +402.000 Ton
- Minimum Batch Deviation Percentage: 95 %
- Maximum Batch Deviation Percentage: 105 %
- Pre Alarm Percentage: 80 %
- Comments: [Empty]
- E-Mail Addresses: [Empty]

The 'Product Transfer Overview' table is as follows:

Product Level	Ok	+1.598 m	Total Observed Volume	Ok	+22'356.869 m³	Product Mass	NO DATA	+0.000 Ton
Gross Observed Volume	Ok	+22'356.869 m³	Gross Standard Volume	NO DATA	+22'356.869 m³	Net Standard Volume	NO DATA	+22'356.869 m³
Flow Direction	Ok	IN	Batch Size(Volume)	Ok	+20'000.000	Batch Size(Mass)	Ok	+402.000
TOV Flow Rate	Ok	+6'971.3	Mass Flow Rate	Ok	+0.0	Transferred Volume	Ok	+8'309.869
Transferred Mass	NO DATA	+0.000	Time To Complete	Ok	00:01:59	Transfer Status	Ok	ACTIVE

Percent Completed: 41.549%

Product\_Transfer\_active

### Product transfer paused

The system treats an Active product transfer as Paused and the product transfer status is changed to "Paused" if:

- the flow rate drops below the minimum volume change rate,
- the rate of change of level drops below the minimum rate of change of level configured under the tank flow calculation details, and
- the quantity of product that has been transferred is less than the minimum batch deviation percentage of the batch size

An image of Tankvision displaying the status as "Paused" is as follows:

The screenshot shows the 'Product Transfer Configuration' window with the following details:

- Source/Destination: [Empty]
- Date & Time of Product Transfer Creation: 01/01/2014 08:37:21 AM
- Transfer Type: [Empty]
- Batch Mode: Volume
- Batch Size Volume: +30'000.000 m³
- Batch Size Mass: +624.000 Ton
- Minimum Batch Deviation Percentage: 95 %
- Maximum Batch Deviation Percentage: 105 %
- Pre Alarm Percentage: 80 %
- Comments: [Empty]
- E-Mail Addresses: [Empty]

The 'Product Transfer Overview' table is as follows:

Product Level	Ok	+2.484 m	Total Observed Volume	Ok	+34'647.771 m³	Product Mass	NO DATA	+0.000 Ton
Gross Observed Volume	Ok	+34'647.771 m³	Gross Standard Volume	NO DATA	+34'647.771 m³	Net Standard Volume	NO DATA	+34'647.771 m³
Flow Direction	Ok	STEADY	Batch Size(Volume)	Ok	+30'000.000	Batch Size(Mass)	Ok	+627.000
TOV Flow Rate	Ok	+0.0	Mass Flow Rate	Ok	+0.0	Transferred Volume	Ok	+20'868.669
Transferred Mass	NO DATA	+0.000	Time To Complete	Ok	00:00:00	Transfer Status	Ok	PAUSED

Percent Completed: 68.529%

Status-Paused\_NXAB20

## Product transfer completed

The product transfer is considered as completed, if:

- The quantity of product that has been transferred so far (calculated as per batch mode) is equal to or more than minimum batch deviation percentage of batch size, and is less than the maximum batch deviation percentage of the batch size; and
- the rate of change of volume is less than the minimum rate of change of volume

An image of Tankvision displaying the status as "Completed" is as follows:

The screenshot shows the 'Product Transfer Configuration' window with the following details:

- Source/Destination: Destination
- Date & Time of Product Transfer Creation: 01/01/2014 02:21:03 PM
- Transfer Type: In
- Batch Mode: Volume
- Batch Size Volume: +40'000.000 m³
- Batch Size Mass: +816.000 Ton
- Minimum Batch Deviation Percentage: 90 %
- Maximum Batch Deviation Percentage: 110 %
- Pre Alarm Percentage: 70 %

The 'Product Transfer Overview' table shows the following data:

Product Level	OK	+3.625 m	Total Observed Volume	OK	+50'416.180 m³	Product Mass	NO DATA	+0.000 Ton
Gross Observed Volume	OK	+50'416.180 m³	Gross Standard Volume	NO DATA	+50'416.180 m³	Net Standard Volume	NO DATA	+50'416.180 m³
Flow Direction	OK	IN	Batch Size(Volume)	OK	+40'000.000	Batch Size(Mass)	OK	+816.000
TOV Flow Rate	OK	+3'502.6	Mass Flow Rate	OK	+0.0	Transferred Volume	OK	+36'367.866
Transferred Mass	NO DATA	+0.000	Time To Complete	OK	00:01:02	Transfer Status	INIT	COMPLETED

Status: Completed\_NXA820



The system generates an event for a completed product transfer. The event details can be viewed in the **Event** tab.

## Product transfer finished

The user may choose to finish the product transfer before the product transfer is completed. The product transfer can be finished, when the tank is in an "Active" transfer stage.

An image of Tankvision displaying the status as "Finished" is as follows:

The screenshot shows the 'Product Transfer Configuration' window with the following details:

- Source/Destination: Source
- Transfer Type: In
- Batch Mode: Volume
- Batch Size: m³
- Minimum Batch Deviation Percentage: 95 %
- Maximum Batch Deviation Percentage: 105 %
- Pre Alarm Percentage: 80 %

The 'Product Transfer Overview' table shows the following data:

Product Level	OK	+47.050 m	Total Observed Volume	Not Calibrated	+650'470.818 m³	Product Mass	NO DATA	+0.000 Ton
Gross Observed Volume	Not Calibrated	+650'470.818 m³	Gross Standard Volume	NO DATA	+650'470.818 m³	Net Standard Volume	NO DATA	+650'470.818 m³
Flow Direction	0.0		Batch Size(Volume)	0.0		Batch Size(Mass)	0.0	
TOV Flow Rate	0.0		Mass Flow Rate	0.0		Transferred Volume	0.0	
Transferred Mass	0.0		Time To Complete	0.0		Transfer Status	INIT	FINISHED

Status: Finished\_NXA820



The system displays a pop up message to confirm about finishing the product transfer.

- When the user manually finishes the product transfer, the system generates and displays the **Product Transfer Report**.
- The system generates an event for product transfer finished by user. The information can be viewed in the **Events** tab.
- The user cannot manually finish the product transfer, if the product transfer status is "Completed".



## Product transfer aborted

The user may choose to abort the product transfer before the product transfer is completed. The product transfer can be "Aborted", when the tank is in an "Active" transfer stage. When the product transfer is aborted, the system does not record the data of starting and ending of product transfer. In such case, the system maintains different sets of data. The data of a

previously completed or finished product transfer are preserved, and the data of the aborted product transfer are discarded.

Product Transfer Overview											
Product Level	Ok	+3.691 m	Total Observed Volume	Ok	+51328.192 m³	Product Mass	ACDATA	+0.000 Ton			
Gross Observed Volume	Ok	+51328.192 m³	Gross Standard Volume	ACDATA	-51328.192 m³	Net Standard Volume	ACDATA	-51328.192 m³			
Flow Direction	Ok	IN	Batch Size(Volume)	Ok	+40000.000	Batch Size(Mass)	Ok	+848.000			
TOV Flow Rate	Ok	+38845.5	Mass Flow Rate	Ok	+0.0	Transferred Volume	Ok	+30343.940			
Transferred Mass	ACDATA	+0.000	Time To Complete	Ok	00:00:14	Transfer Status	INIT	ABORTED			

Status: Aborted\_NXA820

-  The system displays a pop up message to confirm about the aborting of the product transfer.
-  The system generates an event for an aborted product transfer. The event details can be viewed in the **Event** tab.

### Error Messages

1. "Tank cannot be armed for product transfer if "No product" has been assigned to tank"  
This message appears when the user attempts to create a product transfer when "No Product" is assigned to the tank.
2. "The Tank status is "Locked", cannot create a new product transfer for a tank that is locked"  
This message appears when the user attempts to create a product transfer when the tank status is "Locked".
3. "The Tank status is "In Maintenance", cannot create a new product transfer for a tank that is in maintenance"  
This message appears when the user attempts to create a product transfer when the tank status is "In Maintenance".
4. "Batch size cannot be zero, if you do not wish to specify batch size leave the field empty"  
This message appears when the Batch size entered by the user is equal to zero.
5. "Batch size should be greater than zero"  
This message appears when the value of the Batch size entered by the user is less than zero.
6. "Batch size should be smaller than remaining tank capacity"  
This message appears when the transfer type is "In" and the batch size entered by the user is more than the remaining tank capacity.
7. "Batch size should be smaller than available product quantity"  
This message appears when the transfer type is "Out" and the batch size entered by the user is more than the available product quantity.
8. "Minimum batch deviation should be less than maximum batch deviation"  
This message appears when the Minimum batch deviation entered by the user is greater than or equal to maximum batch deviation.
9. "Pre-alarm percentage should be greater than zero"  
This message appears when the Pre-alarm percentage entered by the user is less than or equal to zero.
10. "Pre alarm percentage should be less than minimum batch deviation"  
This message appears when the pre-alarm percentage entered by the user is more than the minimum batch deviation.

## 7.11 How to view a Transfer report

The below described operations can be performed with the default user access rights for an operator ("User access rights", → 13).

The Tankvision system allows the user to arm a tank for product transfer, and is set up to detect the start and end of the product transfer details for a tank. The system records the product transfer data and generates a report for the product transfer with "Completed" and "Finished" statuses, using an appropriate template. You can view or even edit the product transfer report for the last product transfer that has been completed by the system.

### To generate a product transfer report

1. In the navigation tree, click the **Reports** header. Click **Product Transfer Report**. Tankvision displays the screen as follows:

NXA820 - NXAC1001101101		PRODUCT TRANSFER REPORT		Endress+Hauser 	
<b>CONFIGURATION SETTING DETAILS</b>					
Site Name	:	Date (mm/dd/yyyy)	:	01/02/2014	
Site Location	:	Time (HH:MM:SS AM)	:	11:35:38 AM	
<b>PRODUCT TRANSFER DETAILS</b>					
Tank Name	:	Tank-1	Product Transfer Status	:	FINISHED
Product Name	:	Petrol	Transfer Type	:	IN
Transfer Source or Destination	:	DESTINATION	Comments	:	
Batch Size (VOLUME)	:	+40'000.000 m³	Batch Mode	:	VOLUME
Batch Size (MASS)	:	+872.000 Ton	Batch Mode	:	MASS
Maximum Batch Deviation Percentage	:	110 %	Pre-Alarm Percentage	:	80 %
Minimum Batch Deviation Percentage	:	90 %		:	
Product VCF calculation method	:	ASTM D1250-80 -Table 24B	Product RDC calculation method	:	ASTM D1250-80 -Table 23B
Product Liquid Mass Calculation Method	:	NSV * Reference Density	Sediment and Water Percentage	:	0.000000 %
Operator Who Armed the Tank for PT	:	SUPER	Operator Who Finished the Tank for PT	:	SUPER
Operator Who Edited the Tank for PT	:	SUPER		:	
<b>ELEMENT NAME</b>					
		<b>DATA</b>			
		<b>START</b>	<b>END</b>	<b>DELTA</b>	
Product level	:	+1.003 m	+4.281 m	+3.278 m	
Product Temperature	:	+23.8 °C	+22.0 °C	-1.8 °C	
Vapor pressure	:	+25.00 kPa	+24.75 kPa	-0.25 kPa	
Vapor Temperature	:	+1.7 °C	+1.9 °C	+0.2 °C	
Observed density	:	+21.8 kg/m³	+21.8 kg/m³	+0.0 kg/m³	
Free water level	:	+5.025 m	+5.013 m	-0.012 m	
Free water volume	:	+0.000 m³	+0.000 m³	+0.000 m³	
Total observed volume	:	+14'089.113 m³	+59'481.000 m³	+45'391.887 m³	
Gross standard volume	:	-14'089.113 m³	-59'481.000 m³	-45'391.887 m³	
Net standard volume	:	-14'089.113 m³	-59'481.000 m³	-45'391.887 m³	
Product mass	:	+0.000 Ton	+0.000 Ton	+0.000 Ton	
Total mass	:	+0.000 Ton	+0.000 Ton	+0.000 Ton	
Date (mm/dd/yyyy)	:	01/02/2014	01/02/2014	0	
Time (HH:MM:SS AM)	:	11:34:42 AM	11:35:38 AM	0.0	

Product Transfer Report\_NXA820

Field	Description
W&M Approved	This section displays the status of W&M approval.
Configuration Setting Details	This section displays the report of the configuration settings.
Product Transfer Details	This section displays the report of Product Transfer settings. Refer to "Product Transfer Life Cycle" (→ 38) for details.
Element Name	This section displays the result of the product transfer in terms of parameter changes. Refer to "Tank Calculator" (→ 48) for details.

2. Refer to the "View Product Transfer Report" section under the "Reports" chapter for more information on the product transfer report.

## 7.12 How to view and change Tank Status

The below described operations can be performed with the default user access rights for an operator ("User access rights", → 13).

The tanks in the Tankvision system are associated with a status which can be changed by the operator.

To change the tank status for all tanks at once, go to the **Configuration** → **Tank Status** page, → 47.

### To change the tank status

1. Click the **Tank Status** tab. Tankvision displays the screen as follows:



Tank\_Status

Field	Description
Current Status	The system displays the current status of the tank.
Change Status to	<p>Select the appropriate status type from the drop down list. This field allows you to select the status in which the tank is required to function. The statuses are:</p> <ul style="list-style-type: none"> <li>▪ <b>In Operation:</b> The tank is in normal operation.</li> <li>▪ <b>In Maintenance:</b> The tank is under maintenance. A tank is always empty under maintenance, and tank operations such as gauge commands or product transfers cannot be performed. The field scan is not needed.</li> <li>▪ <b>Manual:</b> The tank is in operated manually, which means the system will not measure the data automatically. All tank parameters are in manual mode and the field scan is in off mode. A product transfer can occur.</li> <li>▪ <b>Locked:</b> The tank is generally filled but locked to disallow product transfer. All other activities can be performed.</li> </ul> <p>Refer to "Tank Status Change Matrix" (→ 45) for the activities that can be performed under various tank statuses, and to "Tank Status Indicator" (→ 46) to learn about the notification on the tank status graph.</p>
Comments	Enter the tank related comment information here.

2. Enter the appropriate information in the relevant fields.
  3. Click the **Submit** button to change the tank status.
  4. After saving the settings, Tankvision displays a confirmation message.
-  An event is generated after changing the tank status. The event details can be viewed in the **Event** overview.

### 7.12.1 Tank Status Change Matrix

The activities that can be performed under various tank statuses are as follows:

Activity vs Tank Status	In Operation	Manual	Maintenance	Locked
Inventory Calculation	Yes	Yes	No	Yes
Product Transfer	Yes	Yes	No	No

Activity vs Tank Status	In Operation	Manual	Maintenance	Locked
Gauge Commands	Yes	No	No	No
Raise Change in Volume Alarm	No	No	No	Yes
Field Scan	Yes	No	No	Yes
Raise Alarms	Yes	No	No	Yes

### 7.12.2 Tank Status Indicator

Tankvision indicates the tank status on the **Tank Overview** section on the **Tank Details** tab. When the tank status is modified to "In Operation", the system indicates the tank status on the **Tank Overview** section as follows:

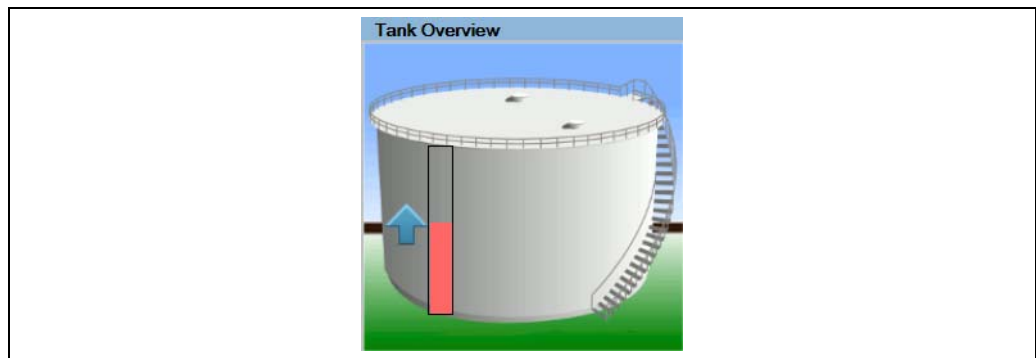

NXA82x\_Tank-Status-Indicator\_Operation

When the tank status is modified to "In Maintenance", the system indicates the tank status on the **Tank Overview** section as follows:

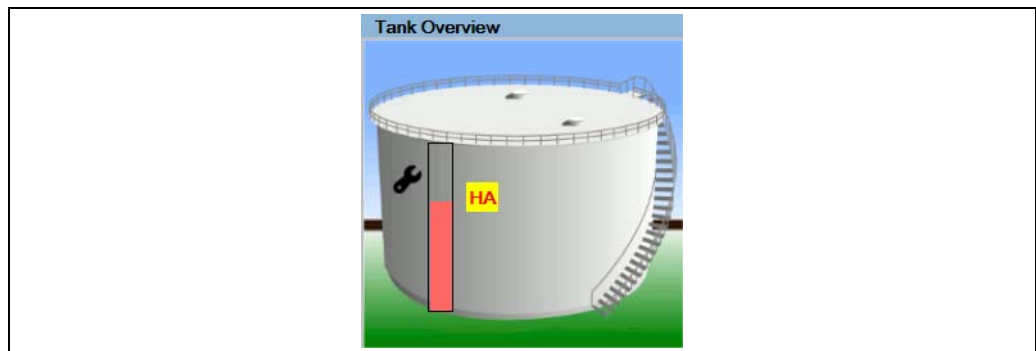

NXA82x\_Tank-Status-Indicator\_Maintenance

When the tank status is modified to "Manual", the system indicates the tank status on the **Tank Overview** section as follows:

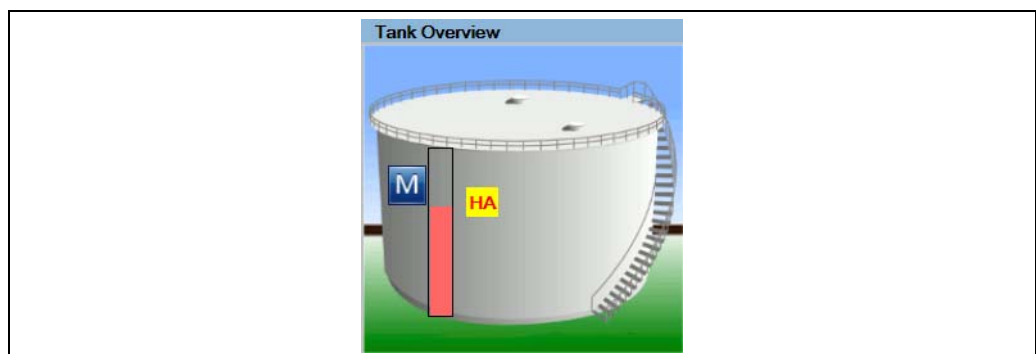

NXA82x\_Tank-Status-Indicator\_Manual

When the tank status is modified to "Locked", the system indicates the tank status on the **Tank Overview** section as follows:

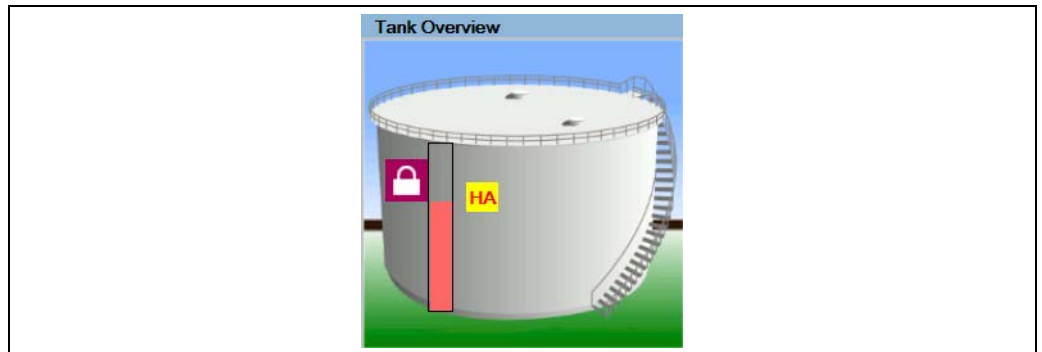

NXAR2x\_Tank-Status-Indicator\_Locked

### 7.12.3 Changing the TankStatus for all Tanks at once

To change the tank status for all tanks at once

1. In the navigation tree, click the **Configuration** header. Click **Tank Status**. Tankvision displays the screen as follows:

Tank Name	Current Status	Change Status To
<input type="checkbox"/> All Tanks		In Operation ▼
Tank-1	In Operation	In Operation ▼
Tank-2	In Operation	In Operation ▼
Tank-3	In Operation	In Operation ▼
Tank-4	In Operation	In Operation ▼
Tank-5	In Operation	In Operation ▼
Tank-6	In Operation	In Operation ▼
Tank-7	In Operation	In Operation ▼
Tank-8	In Operation	In Operation ▼
Tank-9	In Operation	In Operation ▼
Tank-10	In Operation	In Operation ▼
Tank-11	In Operation	In Operation ▼
Tank-12	In Operation	In Operation ▼
Tank-13	In Operation	In Operation ▼
Tank-14	In Operation	In Operation ▼
Tank-15	In Operation	In Operation ▼

NXAR2x\_Configuration\_Tank-Status

2. Set the statuses of the tanks with the **Change Status To** picklists. To change all tanks to the same status, select **All Tanks**.
  3. Click the **Submit** button to change the tank statuses.
  4. After saving the settings, Tankvision displays a confirmation message.
-  An event is generated after changing the tank status. The event details can be viewed in the **Event** overview.

### 7.13 How to do tank calculations

The below described operations can be performed with the default user access rights for an operator ("User access rights", → 13).

The Tankvision system performs inventory calculations based on the measured data scanned from a gauge or entered manually. The system uses the tank and product configuration mainly to perform these calculations. Tankvision provides a tank calculator to evaluate various "what if" scenarios. These scenarios could be:

- What would be the product volume for a certain product level?
- What would be the product level, if a certain quantity of product is pumped into the tank?
- What would be the product volume, if the product level is equal to the high level alarm?

Based on the above mentioned scenarios, the tank calculator would also indicate whether the resulting tank parameter could cause an alarm.

Thus, prior to an actual product transfer, the tank calculator can be used to verify whether it is possible to perform an "out" or "in" product transfer without resulting in an alarm. Any tank parameter that is changed in the tank calculator is used to carry out calculations and display results to evaluate the what-if scenarios. Changing tank parameters in the tank calculator does not change the actual tank data.

#### To use the tank calculator

1. Click the **Tank Calculator** tab. Tankvision displays the screen as follows:

Parameter	Start Value	End Value	Delta Value
Product Level:	+0.300 m	+0.300	+0.000
Product Temperature:	+4.5 °C	+4.5	+0.0
Ambient Temperature:	+0.0 °C	+0.0	+0.0
S & W Percentage:	+0.00 %	+0.00	+0.00
Free Water Level:	+0.000 m	+0.000	+0.000
Observed Density:	+810.0 kg/m³	+810.0	+0.0
Vapor Pressure:	+0.00 kPa	+0.00	+0.00
Total Observed Volume(TOV):	+30.000 m³	+30.000	+0.000
Free Water Volume(FWW):	+0.000 m³	+0.000	+0.000
Sediment and Water Volume (SWV):	+0.000 m³	+0.000	+0.000
Standard Density:	+0.0 kg/m³	+0.0	+0.0
Volume Correction Factor (VCF):	+1.0000000	+1.0000000	+0.000
Gross Observed Volume (GOV):	+30.000 m³	+30.000	+0.000
Gross Standard Volume (GSV):	+30.000 m³	+30.000	+0.000
Net Standard Volume (NSV):	+30.000 m³	+30.000	+0.000
Total Standard Volume (TSV):	+30.000 m³	+30.000	+0.000
Product Mass in Vacuum:	+0.000 Ton	+0.000	+0.000
Product Mass in Air (i.e. Net Weight in Air - NWA)	+0.000 Ton	+0.000	+0.000

NXA82x\_Tank\_Tank-Calculator--Tab

Column	Description
Parameter	This column displays a list of product parameters for which the start and end value can be entered for the purpose of calculation.
Start Value	Enter the appropriate start values for the relevant parameters in the corresponding text boxes. The start value is the initial value of the parameter. For example, the initial level of the product will be the start value for <b>Product Level</b> . The data type for this field is numeric.
End Value	Enter the appropriate end values for the relevant parameters in the corresponding text boxes. The end value is the current or final value of parameter. For example, the current or final level of the product will be the end value for <b>Product Level</b> . The data type for this field is numeric.
Delta Value	The delta values are not editable. The delta value is the difference between the start value and the end value of a parameter. The data type for this field is numeric.

2. Enter the appropriate information in the relevant fields and click the **Calculate** button.



## 7.14 How to view products groups

The below described operations can be performed with the default user access rights for an operator ("User access rights", → 13).

The Tankvision system has a product-tank group feature, where the user can view different products stored in various tanks.

### To view the product-tank group

1. On the Navigation Tree, click the **Products** header. (The number of products configured is displayed in brackets next to the header's name.) The **Products** header expands as follows:

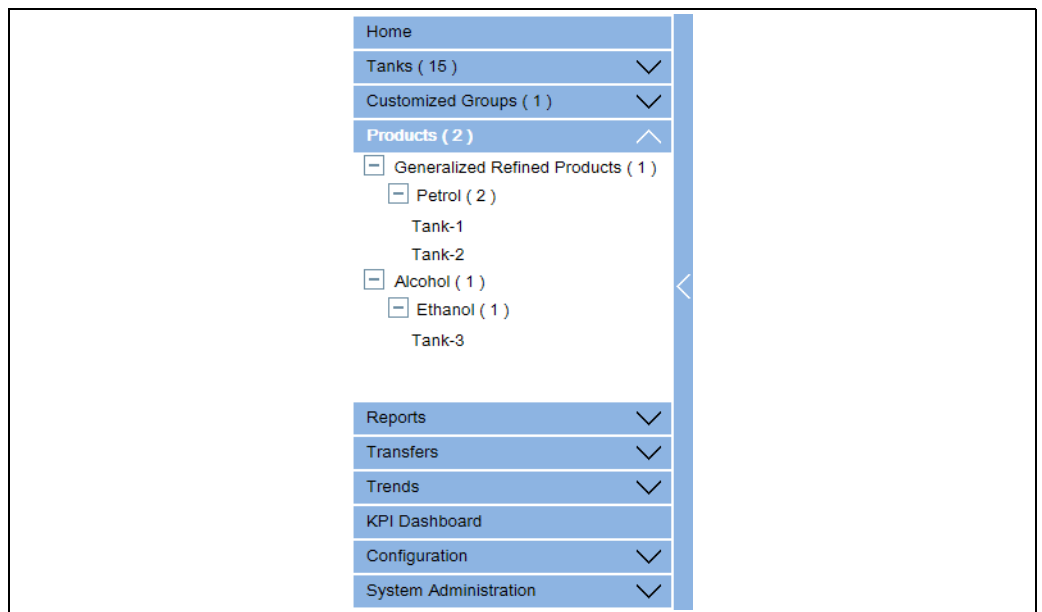



NXA82x\_Menu\_Products

2. In the above figure, the <Product Name> created by the authorized personnel is displayed under the **Products** header. The number shown inside the bracket, is the total number of tanks that contain the product.
3. Click the <Product Name> to display the tanks filled with the relevant product. Tankvision displays the screen as follows:

Tank Name	Product Name	Movement Direction	Tank Status	Tank Comment	Product Level	Secondary Level	Product Temperature	Pressure	Total Observed Volume
Tank-1	Petrol	OUT	In Operation	Tank related comment can be stored here.	+92100.000 mm	+0.000 mm	+0.0 °C	+0.00 kPa	+2421325.75 USgal
Tank-2	Petrol	OUT	Locked(9911.000mm)		+0.000 mm	+0.000 mm	+0.0 °C	+0.00 kPa	+0.00 USgal

Tabular\_View\_of\_the\_Product

4. By default, the system displays the tabular view of the product group in the **Products**-<Product Name> screen.
-  Click the , the system will expand the node and display the names of the tanks that have this product. The user may click on the <Tank Name> to view the detailed information about the tank.

### 7.14.1 Graphical View of the Product-Tank Group Details

To view the product-tank group details in graphical format

1. On the Products - <Product Name> screen, click the **Graphical View** tab. Tankvision displays the screen as follows:

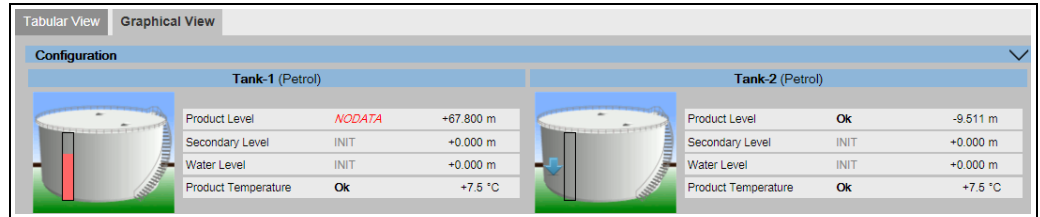

NXA82x\_Product-Tank-Groups\_Graphical-View

Field	Description
<Tank Name> und <Product Name>	The tank names and the product names are displayed for the selected tank group.
Level of Alarm	The current level of alarm is displayed as per the alarm set point.
Graphical Bar	The graphical bar displays the product level and water level.
Product Parameter	Each tank's measured data, viz., product level and product temperature are displayed with the appropriate units. The system also indicates the alarm acknowledgement status using different background colors. The background colors are as follows: <ul style="list-style-type: none"> <li>▪ Dark green - indicates an active and acknowledged alarm</li> <li>▪ Light red - indicates an active and unacknowledged alarm</li> <li>▪ Yellow - indicates an inactive and unacknowledged alarm</li> <li>▪ White - indicates an inactive and acknowledge alarm</li> </ul>
Tanks in a Tank group	The total number of tanks in a tank group is displayed as per the tank group parameter.

**i** A guest user can view the **Non Real Time Product-Tank Group Details** screen. The system displays the measured graphical information of the tanks, when the <Product Name> is selected. The user has to manually refresh the screen to view the latest measured graphical information.

Click  on **Configuration**. Tankvision displays the screen as follows:

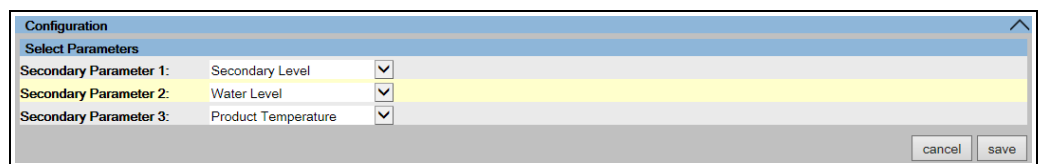

NXA82x\_Product-Tank-Groups\_Graphical-View\_Configuration

Select the secondary parameters that are displayed in the Graphical View from the drop down lists.

Click the **save** button to save the configuration. The configuration is changed for all tanks. Click **cancel** to exit.

### 7.14.2 Tabular View of the Product-Tank Group Details

#### To view the product-tank group details in tabular format

1. On the **Products** - <Product Name> screen, click the **Tabular View** tab. Tankvision displays the screen as follows:

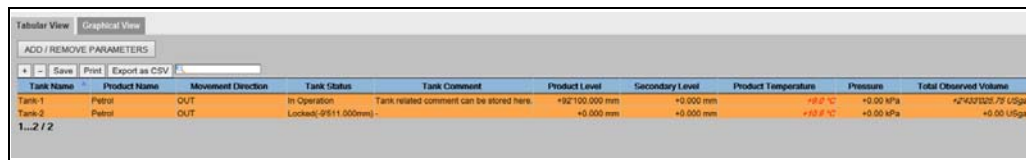

Tabular\_View\_of\_the\_Product

Description of the screen:

1. Displayed columns are selectable (how to add columns to the tabular view, see below): Tank Name, Product Name, Movement Direction, Level Alarms, Tank Status, Tank Comment, Product Level, Secondary Level, Water Level, Product Temperature, Vapour Temperature, Vapour Pressure, Observed Density, Ambient Temperature, Reference Density, Total Observed Volume (TOV), Remaining Tank Capacity, Available Product Volume, Sediment Water Volume, Rate of Change of Level, Rate of Change of Volume, Net Standard Flow Rate, Total Mass Flow Rate, Free Water Volume (FWV), Gross Observed Volume (GOV), Gross Standard Volume (GSV), Net Standard Volume, Product Mass, Total Mass, Total Standard Volume, VCF, Mass in Vapor, Net Weight in Air, Net standard Weight, floating roof adjustment, Floating Roof Position, Tank Shell Correction, Sample Temperature, Vapour Room(Volume), Alcohol Content By Mass, Alcohol Content By Volume, GP Register, Protocol Alarm, Percentage Level, VSP Volume, Gauge Error, Gauge Status, Analog Input, Lab Reference Density, Floating Roof Level 1, Floating Roof Level 2, Floating Roof Level 3, Floating Roof Delta Level and Floating Roof Delta Mass.
2. Description of the colours:
  - Blue: indicates that the level is moving up
  - Brown: indicates that the level is moving down
  - Other colour: indicates that the level is not changing or remains in a certain delta.

 A guest user can view the **Non Real Time Product-Tank Group Details** screen. The system displays the measured tabular information of the tanks, when the <Product Name> is selected. The user has to manually refresh the screen to view the latest measured tabular information.

#### To add columns to the tabular view

1. Click the **ADD / REMOVE PARAMETERS** button. The following pop-up window appears:

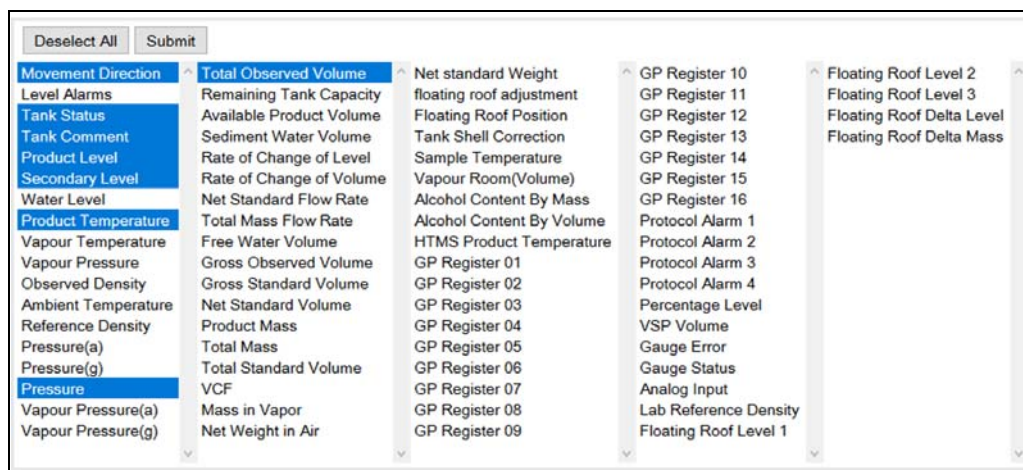

NXA82x\_Products\_Tabular-View\_Pop-Up

2. Select/deselect the columns you want to see /don't want to see.
3. Click the **Submit** button.
4. The tabular view will show the selected values until further changes.

#### To zoom the tabular view

1. Click the **+** button to zoom in and the **-** button to zoom out.

#### To save the tabular view settings

1. Click the **Save** button to save the tabular view settings.

#### To print the tabular view

1. Click the **Print** button to print the table as it is.

#### To export the tabular view

1. Click the **Export as CSV** button to export the table, as it is, as a comma-separated values file.

#### To filter the tabular view

1. Enter the filter criteria into the **Filter** field to filter the displayed data.

## 7.15 How to view customized groups

The below described operations can be performed with the default user access rights for an operator ("User access rights", → 13).

The user can select a tank group from the navigation menu, and can view the tank group details in graphical and tabular format. The graphical and tabular format give a quick feedback about the current tank status. The screen displays the tank data dynamically on a real time basis. The graphical and tabular page shows the tanks in the selected tank group. Each tank is shown with its tank parameters. There are two types of Tank Groups:

1. Static Tank Group: Tank group created by user
2. Dynamic Tank Group: Tank group created by defining filtration criteria. (e.g. All tanks in locked status)

Both types of tank groups are supported with real time graphical information.

The tank group details are viewed by two types of users, viz. operator and guest. The user logging into the system as an operator can view the real time tank group details. The user logging into the system as a guest can view the non-real time tank group details. A guest user has a minimal access to the Tankvision functionality. A guest user can view the tank details, gauge details, tank group and tank overview (all tanks on a specific Tankvision unit) in a non-real time mode. The guest user has to refresh the page to view the current tank data.

**To view real time tank group details**

1. On the Navigation Tree, click the **Customized Groups** header. (The number of tank groups configured is displayed in brackets next to the header's name). The **Customized Groups** header expands as follows:

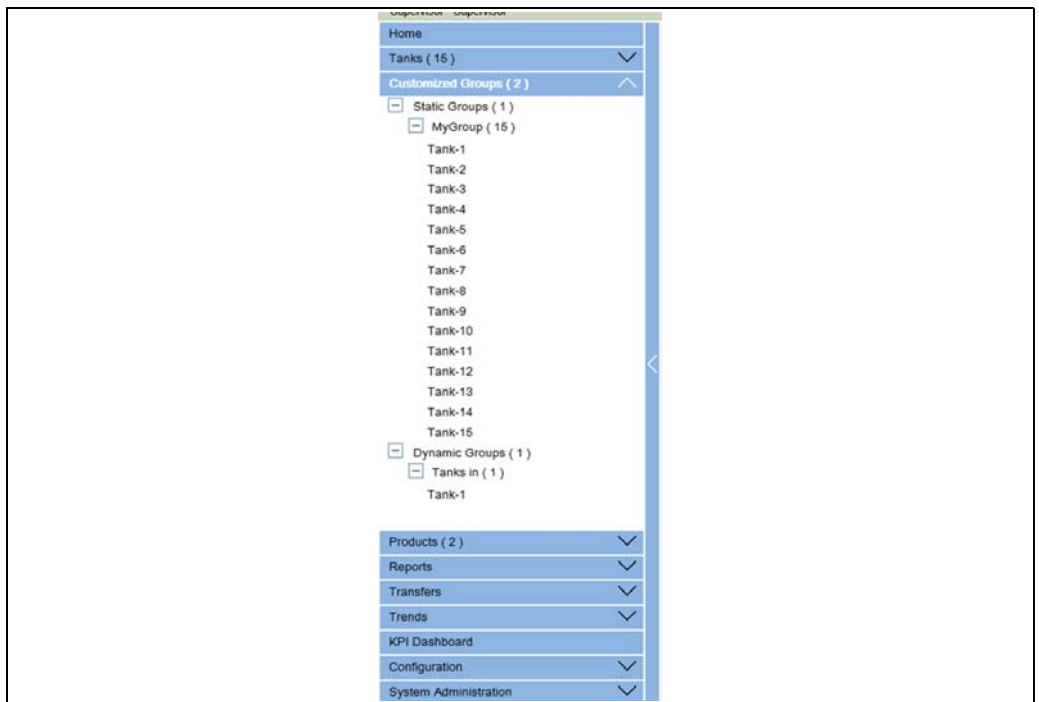

Navigation\_Tree\_Customized\_Group

2. In the above figure, the <Tank Group(s)> name created by the authorized personnel is displayed under the **Customized Groups**. The number of tanks associated in that group is displayed inside the bracket.
3. Click the <Tank Group> name to display the tank status in graphical and tabular format. Tankvision displays the screen as follows:

Tank Name	Product Name	Product Level	Secondary Level	Product Temperature	Pressure	Total Observed Volume
Tank-1	Petrol	+67.800 m	+0.000 m	+4.5 °C	+0.00 kPa	+6780.000 m <sup>3</sup>
Tank-2	Petrol	+5.878 m	+0.000 m	+1.5 °C	+0.00 kPa	+587.800 m <sup>3</sup>
Tank-3	No Product	+0.500 m	+0.000 m	+4.5 °C	+0.00 kPa	+50.000 m <sup>3</sup>
Tank-4	No Product	+0.500 m	+0.000 m	+4.5 °C	+0.00 kPa	+50.000 m <sup>3</sup>
Tank-5	No Product	+0.500 m	+0.000 m	+4.5 °C	+0.00 kPa	+50.000 m <sup>3</sup>
Tank-6	No Product	+0.500 m	+0.000 m	+4.5 °C	+0.00 kPa	+50.000 m <sup>3</sup>
Tank-7	No Product	+0.500 m	+0.000 m	+4.5 °C	+0.00 kPa	+50.000 m <sup>3</sup>

Real\_Time\_Tank\_Group\_Tabular\_View

- By default, the system displays the tabular view of the tank group.

### 7.15.1 Graphical View of the Tank Group Details

To view the tank group details in graphical format

- On the Customized Groups - <Tank Group> name screen, click the **Graphical View** tab. Tankvision displays the screen as follows:

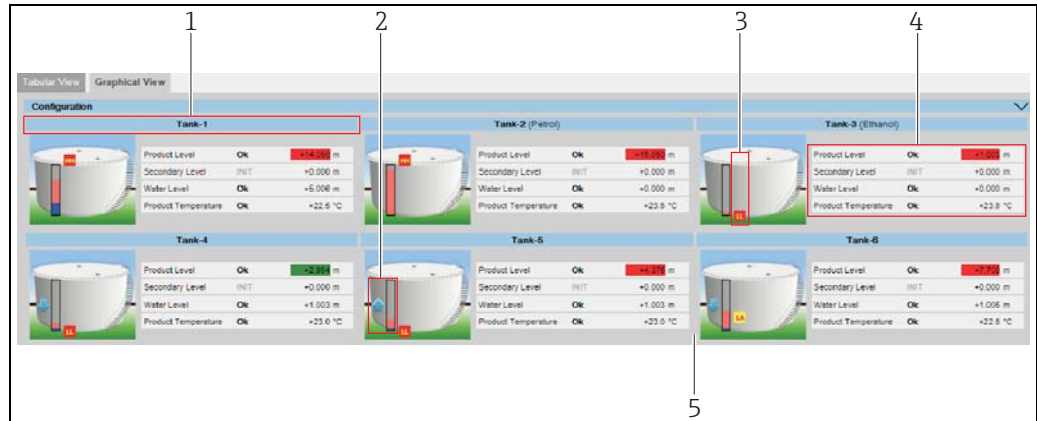

NXAB2x\_Tank-Group-Details\_Graphical-View\_Description

Pos.	Graphical Information	Description
1	<Tank Name> and <Product Name>	The tank names and the product names are displayed for the selected tank group.
2	Graphical Bar	The graphical bar displays the product level and water level. The arrow on the left side of the graphical bar indicates whether the product level is rising or falling.
3	Level of Alarm	The current level of alarm is displayed as per the alarm set points.
4	Product Parameter	Four parameters can be displayed for each tank, three of them can be freely configured under <b>Configuration</b> . Each parameter is displayed with name, status and unit.  The system also indicates the alarm acknowledgement status using different background colors. The background colors are as follows: <ul style="list-style-type: none"> <li>■ Dark green- indicates an active and acknowledged alarm</li> <li>■ Light red- indicates an active and unacknowledged alarm</li> <li>■ Yellow- indicates an inactive and unacknowledged alarm</li> <li>■ White- indicates an inactive and acknowledged alarm</li> </ul>
5	Tanks in a Tank group	The total number of tanks in a tank group is displayed as per the tank group parameter.

Depending on the tank group type the graphical information is as follows:

Tank Group Type	Graphical Information
Static Tank Group	The system displays the measured graphical information of the tanks at the time of selecting the relevant tank group.

Tank Group Type	Graphical Information
Dynamic Tank Group	<p>The user can view the measured graphical information of the tanks, which will be shown dynamically on the web page. The user can view the information on a real time basis.</p> <ol style="list-style-type: none"> <li>In case, a product transfer is taking place under a dynamic tank group, the tank will be shown under (a) the <b>Tanks in Armed</b> tank group, if the user has created a new product transfer for a tank, or (b) the <b>Tanks in Transfer</b> tank group, if the status of product transfer is changed to "Active" from the "Armed" stage.</li> <li>If the tank group is customized, then the tanks will be displayed in the tank group based on the filtration criteria that have been configured. For example, if <b>Alarm Type</b> is selected as <b>High Alarm</b> in the <b>Add New Dynamic Tank Group</b> screen, then the tank group will display only those tanks with <b>High Alarm</b> on the <b>Real Time Tank Group</b> screen.</li> </ol>

### 7.15.2 Tabular View of the Tank Group Details

To view the tank group details in tabular format

- On the **Customized Groups** - <Tank Group> name screen, click the **Tabular View** tab. Tankvision displays the screen as follows:

Tank Name	Product Name	Product Level	Secondary Level	Product Temperature	Pressure	Total Observed Volume
Tank-1	Petrol	+67.800 m	+0.000 m	+4.5 °C	+0.00 kPa	+6780.000 m³
Tank-2	Petrol	+5.878 m	+0.000 m	+1.5 °C	+0.00 kPa	+587.800 m³
Tank-3	No Product	+0.500 m	+0.000 m	+4.5 °C	+0.00 kPa	+50.000 m³
Tank-4	No Product	+0.500 m	+0.000 m	+4.5 °C	+0.00 kPa	+50.000 m³
Tank-5	No Product	+0.500 m	+0.000 m	+4.5 °C	+0.00 kPa	+50.000 m³
Tank-6	No Product	+0.500 m	+0.000 m	+4.5 °C	+0.00 kPa	+50.000 m³
Tank-7	No Product	+0.500 m	+0.000 m	+4.5 °C	+0.00 kPa	+50.000 m³

### 7.16 How to view transfer groups

The below described operations can be performed with the default user access rights for an operator ("User access rights", → 13).

To view the product transfer group details in graphical format

- On the **Transfers** - <Product Transfer Group Name> screen, click the **Graphical View** tab. Tankvision displays the screen as follows:

Configuration	Tank-1 (Petrol)	Tank-2 (Petrol)	Tank-3 (Petrol)
Product Level	OK +1.000 m	OK +1.000 m	OK +1.000 m
Secondary Level	INIT +0.000 m	INIT +0.000 m	INIT +0.000 m
Water Level	OK +5.013 m	OK +0.000 m	OK +0.000 m
Product Temperature	OK +22.1 °C	OK +23.1 °C	OK +23.1 °C

## 7.17 How to issue reports

The below described operations can be performed with the default user access rights for an operator ("User access rights", → [13](#)).

In this chapter, you will learn how to generate reports.

### To generate a report

1. On the Navigation Tree, click the **Reports** header. It expands as follows:

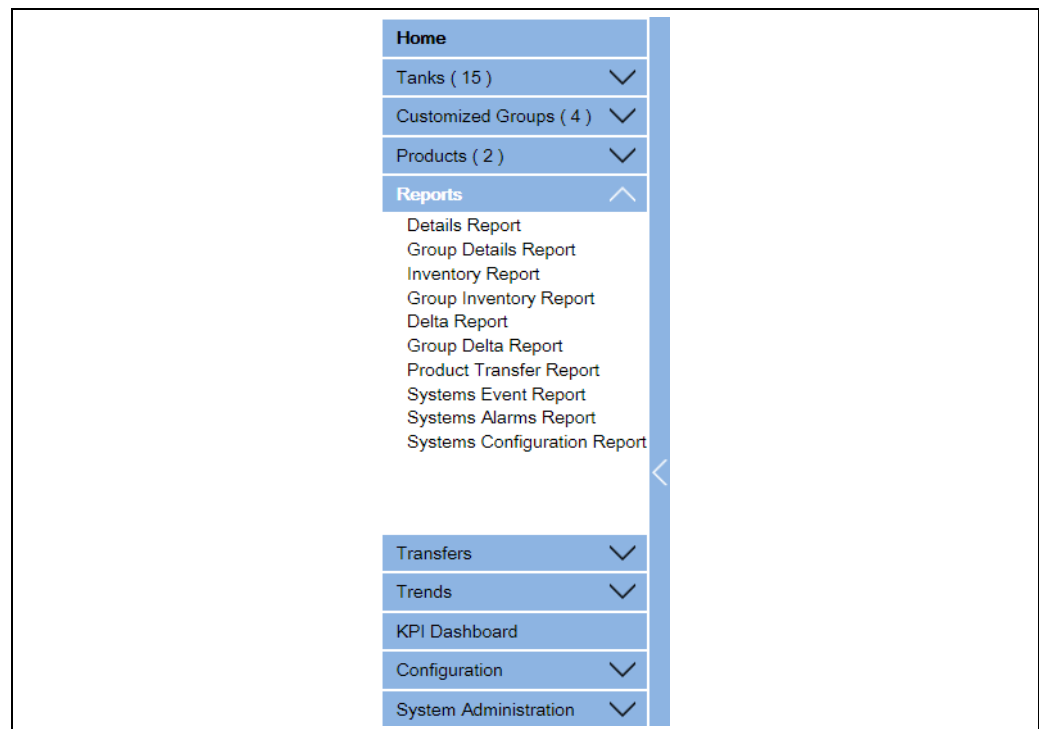

NXA82x\_Reports

2. Select the type of report you are going to configure from the list.

Depending on the type of Tankvision unit and the system configuration, the following report types may be available:

- System Configuration Report - Tank Scanner<sup>2)</sup>
- System Configuration Report - Data Concentrator<sup>2)</sup>
- System Configuration Report - Host Link<sup>2)</sup>
- Product Transfer Report
- Systems Event Report
- Systems Alarm Report
- Tank Delta Report
- Tank Details Report
- Tank Group Details Report
- Inventory Report (V01.04.00)

3. On the following page, define which data are to be included into the report and which report template is to be used.
4. Click the **Submit** button.
5. After a couple of seconds Tankvision displays the report.

2) Depending on the Tankvision unit.



### 7.17.1 Select NXA820 Configuration Details

Select\_NXA820\_Configuration\_Details

Field	Description
Alarm Settings	Generate a report of the alarm settings.
Trend Settings	Generate a report of the Trend settings.
Field Scan Settings	Generate a report of the Field Scan settings.
Gauge Command Settings	Generate a report of the Gauge Command settings.
Tank Shell Calculation Details	Generate a report of the Tank Shell Calculation Details.
Tank General Details	Generate a report of the Tank General Details.
Flow Calculation Details	Generate a report of the Flow Calculation Details.
Inventory Calculation Details	Generate a report of the Inventory Calculation Details.
Select Report Template	Allows to select the report template to be used for the product transfer report.
Network Configuration	Generate a report of the Network Configuration.
Local User Configuration	Generate a report of the Local User Configuration.
Field Scan Configuration	Generate a report of the Field Scan Configuration.
Tank Configuration specific to NXA820	Generate a report of the Tank Configuration specific to NXA820.
Water content calculation Details	Generate a report of the Water content calculation Details.
Floating Roof Details	Generate a report of the Floating Roof Details.
Tank Capacity Details	Generate a report of the Tank Capacity Details.
Alarms Setting For Calculated Data	Generate a report of the Alarms Settings For Calculated Data.
Tank Calibration Settings	Generate a report of the Tank Calibration Settings.

1. Click the **Submit** button.
2. After a couple of seconds Tankvision displays the report.

### 7.17.2 Select Product Transfer Details

Field	Description
Select Report Template	Selection list for installed Product Transfer report templates. If additional templates are installed user must select the wanted template. By default first template is selected.

### 7.17.3 Event Report

Field	Description
Select Template	Allows to select the report template to be used for event report.
Start Date	Define the start date (and time) for the event report.
End Date	Define the end date (and time) for the event report.

1. Click the **View Report** button.
2. After a couple of seconds Tankvision displays the report.

### 7.17.4 Alarm Report

Field	Description
Select Template	Allows to select the template to be used to generate the alarm report.
Start Date	Define the start date (and time) for the alarm report.
End Date	Define the end date (and time) for the alarm report.
Alarm Type	Allows to select the type of alarm to be included into the alarm report.

1. Click the **View Report** button.
2. After a couple of seconds Tankvision displays the report.

### 7.17.5 Select Tanks For Tank Report

Select\_Tanks\_For\_Report

Field	Description
Select Tanks	Allows to select the tanks to be included into the Tank report.
Select Groups	Allows to select the group of tanks to be included into the tank report.
Select Template	Allows to select the template to be used to generate the tank report.
Start Date	Define the start date (and time) for the tank report.
End Date	Define the end date (and time) for the tank report.

1. Click the **View Report** button.
2. After a couple of seconds Tankvision displays the report.

### 7.17.6 Select Tanks For Tank Detail Report

In case of using a Tankvision Data Concentrator with serial printer port option an additional print report button **PBT Report** is available.

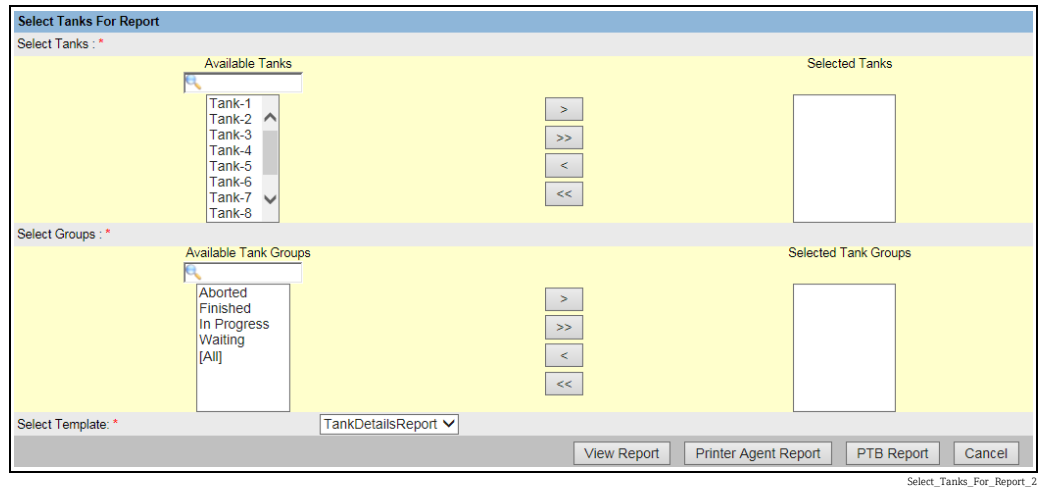

To use this functionality an appropriate template only containing plain text must be selected.

Field	Description
Select Tanks	Allows to select the tanks to be included into the Tank detail report.
Select Groups	Allows to select the group of tanks to be included into the tank detail report.
Select Template	Allows to select the template to be used to generate the tank detail report.

1. Click the **View Report** button.
2. After a couple of seconds Tankvision displays the report.

#### How to get a print out

Click on **Printer Agent Report** to initiate a print out.

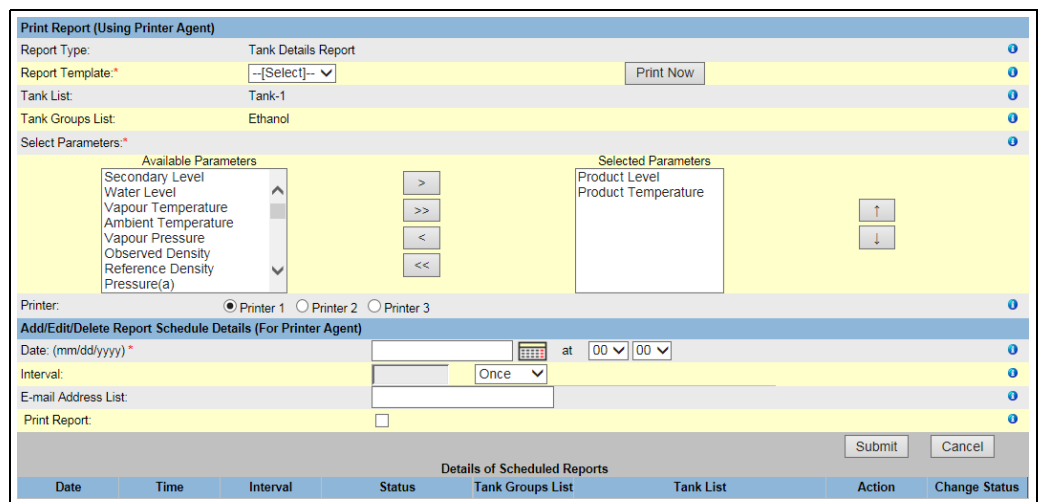

Select Template, the parameters of the selected Tanks/Tank Groups and the printer. With **Print now** the report is immediately send (via the Tankvision Printer Agent) to the selected

printer. In the section **Add/Edit/Delete Report Schedule Details (for printer agent)**<sup>3)</sup> a scheduled print out can be set:

- As 1 time event by selecting a date and time
- As periodic event by selecting in addition to start day and time the interval

An email address can be entered the report should be send to and if a report should be printed can be selected.

Click on **PTB Report** to initiate a print out via the connected serial plain text printer (Data Concentrator NXA821 only).

NXA82x\_Manage-Reports\_PTB-Report\_Tank-Details

### 7.17.7 Select Tank Groups For Report

NXA82x\_Reports\_Group-Delta-Report

Field	Description
Select Groups	Allows to select the group of tanks to be included into the tank group report.
Select Template	Allows to select the template to be used to generate the tank group report.
Start Date	Define the start date (and time) for the tank group report.
End Date	Define the end date (and time) for the tank group report.

1. Click the **View Report** button.
2. After a couple of seconds Tankvision displays the report.

3) Printer Agent, see BA00426G/00/EN Chapter "Tankvision Printer Agent".

### 7.17.8 Select Tank Groups For Detail Report

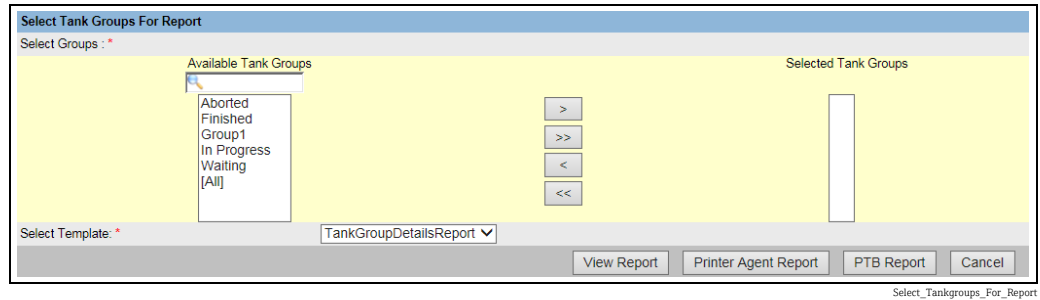

Field	Description
Select Groups	Allows to select the group of tanks to be included into the tank group report.
Select Template	Allows to select the template to be used to generate the tank group report.

1. Click the **View Report** button.
2. After a couple of seconds Tankvision displays the report.

#### How to get a print out

Click on **Printer Agent Report** to initiate a print out.

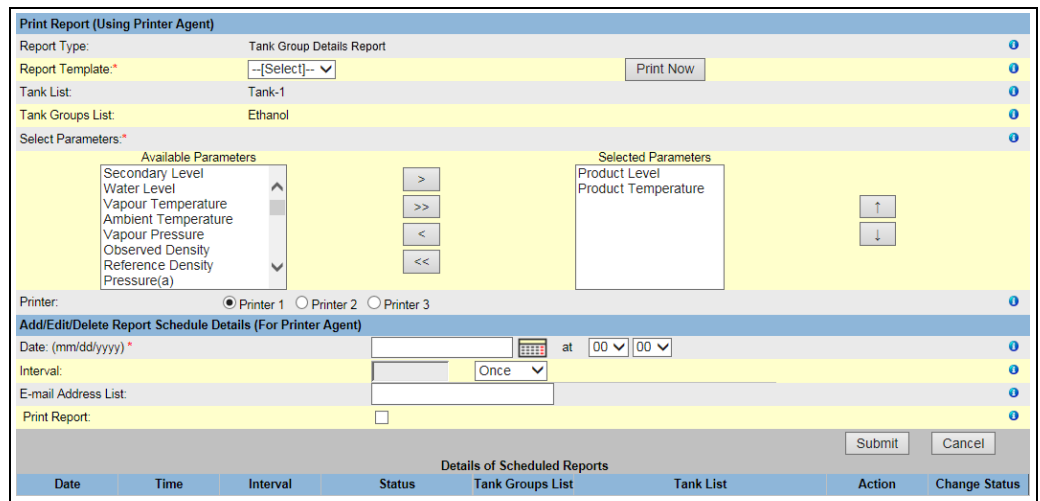

Select Template, the parameters of the selected Tanks/Tank Groups and the printer. With **Print now** the report is immediately send (via the Tankvision Printer Agent) to the selected printer.

In the section **Add/Edit/Delete Report Schedule Details (for printer agent)**<sup>4)</sup> a scheduled print out can be set:

- As 1 time event by selecting a date and time
- As periodic event by selecting in addition to start day and time the interval

An email address can be entered the report should be send to and if a report should be printed can be selected.

Click on **PTB Report** to initiate a print out via the connected serial plain text printer (Data Concentrator NXA821 only).

4) Printer Agent, see BA00426G/00/EN Chapter "Tankvision Printer Agent".

NXA82x\_Manage-Reports\_PT8-Report\_Tank-Group-Details

## 7.18 How to view and acknowledge alarms

The below described operations can be performed with the default user access rights for an operator ("User access rights", → 13).

### 7.18.1 Overview of the Alarm and Event Panel

The **Alarm and Event Panel** of the Tankvision system displays an overview of the Alarms and Events generated by the system. The system will also pop up the message to the user in the local personal computer if an alarm pop up application is installed on that workstation.

#### Alarm Summary

Alarms:

Alarms are conditions pertaining to the functioning of the Tank or Tank elements. These conditions must be communicated to the user. The user may take the necessary actions based on the critical alarm displayed on the screen. These conditions are pre-defined by the user with valid access rights (for example, supervisor/ technician) while configuring a tank and the tank elements.

The Tankvision system is configured to raise various alarms based on measured data, calculated tank data, and alarm settings. The system continuously monitors the measured and calculated data and compares them with the preset alarm conditions such as Hold-off time and set point values. Whenever the value of a measured datum deviates from the set point value and remains deviated for a time span greater than or equal to the hold-off time, the system raises the appropriate alarm. The alarm will appear in the **Alarm** overview tab on the respective unit. The Operators receive the alarm notification on their computer screen in the form of a pop up window.

#### To view the Alarm Summary

1. Click the **Alarm** tab. Tankvision displays the alarm information as follows:

Alarm\_Overview

Field	Description
Date	This column displays the date and time at which the alarm was raised.
Event Type	This column indicates whether the alarm that is raised is a system alarm.
Status	This column indicates the status of the alarm in terms of <b>Active</b> or <b>Inactive</b> . Active Alarm: The alarm is active and not yet acknowledge by an operator. Inactive Alarm: The alarm is inactive and not acknowledged by an operator.

Field	Description
Ack Status	This column indicates whether an alarm is acknowledged or not by an operator <b>ACK:</b> The alarm is acknowledged. <b>UNACK:</b> The alarm is not acknowledged.
Element	This column indicates the name of the data element that has triggered the alarm. For example: level, temperature, pressure, etc. If the value of a data element deviates from the set point value the system raises an alarm.
Sub Type	This column indicates the severity of alarm that is raised. Alarm types range from those with highest priority to those with least priority. The examples for alarm sub- types are, "HH", "HL", "LA", etc.
Object	This column indicates the source of the alarm such as a tank, product, user or a Tankvision unit.
Value	This column indicates the currently measured value of the data element, due to which the alarm was raised, with its corresponding unit.
Email	This column indicates the e-mail delivery status: whether an e-mail was sent successfully to the configured mail server or not. <b>OK:</b> The e-mail was successfully sent. <b>FAILED:</b> The e-mail-sending failed.
UserID	This column indicates the name of the user which was logged in at the time when the alarm was generated.
FGTagName	This column indicates the tag name of the Tankvision unit which has raised the alarm. The FGTagName is the host name of the server.
Event ID	This column indicates the event ID of the alarm. Every Tankvision unit has a unique numerical ID.
Option	This column allows the user to acknowledge an alarm if required. The user can acknowledge the alarm once he makes sure that the specific condition is under control. This acknowledgement status is broadcast to all Tankvision units. <b>ACK:</b> The <b>ACK</b> button appears when an alarm needs to be acknowledged. A blank field appears when the alarm has already been acknowledged. Reference: Refer to "Types of Alarms" (→ 66) and "Alarm Color Schemes" (→ 67).

 Whenever you acknowledge an alarm, the system raises and displays the appropriate event.

### Event Summary

Events:

Apart from alarms, the Tankvision system also generates various "system events". System events are generated for changes in the state of system or for certain actions carried out by users. Unlike alarms, events need not to be acknowledged by users. Examples of system events are configuration changes, Start Field Scan, Stop Field Scan, Alarm ACK, etc.

#### To view the event summary

1. Click the **Event** tab. Tankvision displays the event information as follows:

Alarm Event Open in new Window									
Date	Event Type	Object	Value	Email	UserID	FGTagName	Event ID		
06/11/2015 05:50:38 PM	Login/Logout Information	Login		N/A Not Configured	SUPER	TS1			67
06/08/2015 06:36:49 PM	Login/Logout Information	Logout		N/A Not Configured	SUPER	TS1			66
06/08/2015 11:10:35 AM	Login/Logout Information	Login		N/A Not Configured	SUPER	TS1			65
06/07/2015 07:23:57 PM	Login/Logout Information	Logout		N/A Not Configured	SUPER	TS1			64
06/07/2015 05:50:29 PM	Login/Logout Information	Login		N/A Not Configured	SUPER	TS1			63
06/06/2015 07:10:00 PM	Login/Logout Information	Logout		N/A Not Configured	SUPER	TS1			62

Events (Overview)

Field	Description
Date	This column displays the date and time at which the alarm was raised.
Event Type	This column indicates whether the alarm that is raised is a system malfunction alarm or a change in system configuration.



Field	Description
Object	This column indicates the source of the alarm such as a tank, product, user or a Tankvision unit.
Email	This column indicates the e-mail delivery status: whether an e-mail was sent successfully to the configured mail server or not. <b>OK:</b> The e-mail was successfully sent. <b>FAILED:</b> The e-mail-sending failed.
User ID	This column indicates the logon name of the user.
FGTagName	This column indicates the tag name of the Tankvision unit which has raised the event or alarm. The FGTagName is the host name of the server.
Event ID	This column indicates the Identification (ID) numbers of the Tankvision units in concern. Every Tankvision unit has a unique numerical ID.

### Open Alarms and Events in new window

You can open alarms and events in a new window.

#### To open alarms and events in a new window

1. Click the **Open in new Window** tab. Tankvision displays a new "Alarm and Event" window as follows:

Date	Event Type	Status	Ack Status	Element	Sub Type	Object	Value	Email	UserID	FGTagName	Event ID
01/02/2014 12:03:01 PM	ALARM	ACTIVE	UNACK	High Lvl Alarm	Tank-2	Product Level	+10 000 in Not Configured	N/A	N/A	NXAC1001101101	1
01/02/2014 12:05:06 PM	ALARM	ACTIVE	UNACK	High Alarm	Tank-2	Product Level	+10 000 in Not Configured	N/A	N/A	NXAC1001101101	2
01/02/2014 12:05:52 PM	ALARM	INACTIVE	UNACK	Low Lvl Alarm	Tank-2	Product Level	+2 000 in Not Configured	N/A	N/A	NXAC1001101101	3
01/02/2014 12:05:53 PM	ALARM	INACTIVE	UNACK	Low Alarm	Tank-2	Product Level	+2 000 in Not Configured	N/A	N/A	NXAC1001101101	4
01/02/2014 12:06:49 PM	ALARM	ACTIVE	UNACK	High Alarm	Tank-1	Product Level	+10 000 in Not Configured	N/A	N/A	NXAC1001101101	5
01/02/2014 12:06:47 PM	ALARM	ACTIVE	ACK	High High Alarm	Tank-1	Product Level	+10 000 in Not Configured	N/A	N/A	NXAC1001101101	6
01/02/2014 12:06:28 PM	ALARM	INACTIVE	UNACK	Low Lvl Alarm	Tank-1	Product Level	+2 000 in Not Configured	N/A	N/A	NXAC1001101101	7

NXAB2x\_Alarm-Event\_new-window\_Alarm

Date	Event Type	Object	Value	Email	UserID	FGTagName	Event ID
01/02/2014 12:05:44 PM	Config Change	Tank-2	N/A Not Configured	SUPER	NXAC1001101101		34
01/02/2014 12:03:44 PM	Alarm ACK	Tank-1	5 Not Configured	Super	NXAC1001101101		33
01/02/2014 12:03:36 PM	Alarm ACK	Tank-1	3 Not Configured	Super	NXAC1001101101		32
01/02/2014 12:00:59 PM	Config Change	Tank-1	N/A Not Configured	SUPER	NXAC1001101101		31
01/02/2014 11:59:41 AM	Alarm ACK	Tank-1	2 Not Configured	SUPER	NXAC1001101101		30
01/02/2014 11:59:07 AM	Transfer Cancelled	Tank-3	N/A Not Configured	SUPER	NXAC1001101101		29
01/02/2014 11:58:46 AM	Transfer Cancelled	Tank-2	N/A Not Configured	SUPER	NXAC1001101101		28
01/02/2014 11:58:29 AM	Transfer Cancelled	Tank-1	N/A Not Configured	SUPER	NXAC1001101101		27
01/02/2014 11:54:05 AM	Transfer Armed	Tank-1	N/A Not Configured	SUPER	NXAC1001101101		26
01/02/2014 11:53:48 AM	Transfer Abort	Tank-1	N/A Not Configured	SUPER	NXAC1001101101		25
01/02/2014 11:52:23 AM	Transfer Armed	Tank-1	N/A Not Configured	SUPER	NXAC1001101101		24
01/02/2014 11:51:35 AM	Transfer Modified	Tank-3	N/A Not Configured	SUPER	NXAC1001101101		23
01/02/2014 11:51:29 AM	Transfer Armed	Tank-3	N/A Not Configured	SUPER	NXAC1001101101		22
01/02/2014 11:51:06 AM	Transfer Armed	Tank-2	N/A Not Configured	SUPER	NXAC1001101101		21
01/02/2014 11:49:06 AM	Config Change	NXAC1001101101	N/A Not Configured	SUPER	NXAC1001101101		20
01/02/2014 11:48:25 AM	Config Change	Tank-3	N/A Not Configured	SUPER	NXAC1001101101		19
01/02/2014 11:48:02 AM	Config Change	Tank-2	N/A Not Configured	SUPER	NXAC1001101101		18
01/02/2014 11:47:06 AM	Config Change	Tank-3	N/A Not Configured	SUPER	NXAC1001101101		17
01/02/2014 11:46:41 AM	Config Change	Tank-2	N/A Not Configured	SUPER	NXAC1001101101		16
01/02/2014 11:43:23 AM	Transfer Abort	Tank-1	N/A Not Configured	SUPER	NXAC1001101101		15
01/02/2014 11:42:39 AM	Transfer Armed	Tank-1	N/A Not Configured	SUPER	NXAC1001101101		14
01/02/2014 11:35:46 AM	Transfer Finish	Tank-1	N/A Not Configured	SUPER	NXAC1001101101		13
01/02/2014 11:34:49 AM	Transfer Armed	Tank-1	N/A Not Configured	SUPER	NXAC1001101101		12
01/02/2014 11:34:01 AM	Config Change	Tank-1	N/A Not Configured	SUPER	NXAC1001101101		11
01/02/2014 11:02:17 AM	Config Change	Tank-1	N/A Not Configured	SUPER	NXAC1001101101		10
01/02/2014 11:00:32 AM	Config Change	Petrol	N/A Not Configured	SUPER	NXAC1001101101		9
01/02/2014 11:00:10 AM	Config Change	Petrol	N/A Not Configured	SUPER	NXAC1001101101		8
01/02/2014 10:58:59 AM	Config Change	Petrol	N/A Not Configured	SUPER	NXAC1001101101		7
01/02/2014 10:59:10 AM	Config Change	NXAC1001101101	N/A Not Configured	SUPER	NXAC1001101101		6
01/02/2014 10:58:56 AM	Alarm ACK	Tank-1	1 Not Configured	SUPER	NXAC1001101101		5
01/02/2014 10:58:18 AM	Config Change	NXAC1001101101	1 Not Configured	SUPER	NXAC1001101101		4
01/02/2014 10:57:36 AM	Login/Logout Information	Login	N/A Not Configured	SUPER	NXAC1001101101		3
01/02/2014 10:52:48 AM	Config Change	Network	N/A Not Configured	SUPER	NXAC1001101101		2
01/02/2014 10:52:22 AM	Login/Logout Information	Login	N/A Not Configured	SUPER	NXAC1001101101		1

NXAB2x\_Alarm-Event\_new-window

Select the **Alarm** or **Event** tab. The attributes are the same as described in "Alarm Summary" and "Event Summary" (see above).

#### To zoom the Alarm or Event view

1. Click the + button to zoom in and the - button to zoom out.

#### To save the Alarm or Event view settings

1. Click the **Save** button to save the **Alarm** or **Event** view settings.

**To print the Alarm or Event view**

1. Click the **Print** button to print the table as it is.

**To acknowledge all alarms**

1. Click the **Acknowledge all** button to acknowledge all alarms.

**To filter the Alarm or Event view**

1. Enter the filter criteria into the **Filter** field to filter the displayed alarms or events.

**7.18.2 Types of Alarms**

Alarm Sub-Types:

The Tankvision system raises different types of alarms depending on the value of a data element such as product level, temperature, pressure, etc. in comparison with the set point. Different alarm types are described in the table below.

Sub Type	Description	Is Set off
HH	High High Alarm	Whenever the value of a data element raises above the HH set point and remains there for an interval greater than or equal to the hold-off time for the alarm. Data Elements that set off alarms when they deviate from the predefined set point value, are as follows: Product Level, Temperature, Pressure, Density, Product Secondary level, Water level, Vapor pressure, Vapor temperature.
HA	High Alarm	Whenever the value of a data element raises above the HA set point and remains there for an interval greater than or equal to the hold-off time for the alarm. This alarm sub-type is similar to HH but with lower severity than HH. The set point for HA is lower than the set point for HH.
MF	Max Fill Alarm	The Max. Fill Alarm (MF) is indicating that the tank which is filling has reached or exceeded the Normal fill level.  The normal fill level (normal capacity) may be defined as the level to which the tank will intentionally be filled on a routine basis, using the normal process control system. The normal fill level will be dependent on the preceding levels and should be sufficiently far below the LAH to avoid spurious activation, e. g. due to level surges during filling or thermal expansion of the contents. This level is also called Maximum working level.  Enter the appropriate value for the Max. Fill Alarm set point. This set point is used to detect whether any of the following parameters have reached their respective MF alarm value, namely: Product Level.  The MF Alarm set point should be less than the HA alarm for the corresponding parameter and less than the Gauge Reference Height. The data type for this field is numeric.
LA	Low Alarm	Whenever the value of a data element falls below the LA set point and remains there for an interval greater than or equal to the hold-off time for the alarm.
LL	Low Low Alarm	Whenever the value of a data element falls below the LL set point and remains there for an interval greater than or equal to the hold-off time for the alarm. This alarm sub-type is similar to LA but with higher severity than LA. The set point for LL is lower than the set point for LA.
CH	Change Alarm	Whenever the rate of change of the data element level increases above the CH set point and remains above there for an interval greater than or equal to the hold-off time for the alarm. This alarm is raised only when the tank is in the "Locked" status (→ 45).

Sub Type	Description	Is Set off
DF	Difference Alarm	Whenever the absolute value of the difference between product level and product secondary level increases above the DF set point and remains there for an interval greater than or equal to the hold-off time for the alarm.
FL	Fail Alarm	Whenever the gauge status received from a gauge indicates that the gauge has failed.
CO	Gauge Communication Error Alarm	Whenever the communication with a gauge fails due to a timeout error.
TO	Time out / Age Alarm	Whenever the data received from a gauge is too old.
SE	Flash drive is full	Whenever the flash drive is full (e.g. due to archived data).

### 7.18.3 Alarm Color Schemes

The Tankvision system highlights the alarms using different text and background colors to indicate the priority of each alarm as shown in the figure below.

Date	Event Type	Status	Ack Status	Element	Sub Type	Object	Value	Email	UserID	FOTagName	Event ID
11/02/2014 12:06:00 PM	ALARM	ACTIVE	UNACK	High High Alarm	Tank-2	Product Level	+18.000 m/Not Configured	N/A		NOAC1001101101	
11/02/2014 12:06:00 PM	ALARM	ACTIVE	UNACK	High Alarm	Tank-2	Product Level	+18.000 m/Not Configured	N/A		NOAC1001101101	
11/02/2014 12:06:00 PM	ALARM	INACTIVE	UNACK	Low Low Alarm	Tank-2	Product Level	+2.000 m/Not Configured	N/A		NOAC1001101101	
11/02/2014 12:06:00 PM	ALARM	INACTIVE	UNACK	Low Alarm	Tank-2	Product Level	+2.000 m/Not Configured	N/A		NOAC1001101101	
11/02/2014 12:06:00 PM	ALARM	ACTIVE	UNACK	High Alarm	Tank-1	Product Level	+18.000 m/Not Configured	N/A		NOAC1001101101	
11/02/2014 12:06:47 PM	ALARM	ACTIVE	ACK	High High Alarm	Tank-1	Product Level	+18.000 m/Not Configured	N/A		NOAC1001101101	

Alarm\_Overview

Background Color	Text Color	Indicates
Dark Green	Bright Yellow	An active and acknowledged alarm
Light Red	Bright Yellow	An active and unacknowledged alarm
Yellow	Red	An inactive and unacknowledged alarm
White	Black	An inactive and acknowledged alarm

### 7.18.4 Acknowledging an Alarm

One of the important aspects of an alarm is alarm acknowledgement. As long as an alarm is not acknowledged, a new alarm of the same kind for the same tank is not generated, even if the related datum again crosses the configured set point. Therefore, a new alarm of the same type is generated only after the current alarm has become inactive and has been acknowledged by the user.

Alarm acknowledgment ensures that the alarm condition has been brought to the notice of operators. Alarms can be acknowledged from the Alarm summary displayed in the **Alarm and Event** Panel of the user interface or alarm pop up agent, or from a host system connected to the Tankvision system.

#### To acknowledge an alarm

1. Double-click the alarm in the alarm summary.

Date	Event Type	Status	Ack Status	Element	Sub Type	Object	Value	Email	UserID	FOTagName	Event ID
11/02/2014 12:06:00 PM	ALARM	ACTIVE	UNACK	High High Alarm	Tank-2	Product Level	+18.000 m/Not Configured	N/A		NOAC1001101101	
11/02/2014 12:06:00 PM	ALARM	ACTIVE	UNACK	High Alarm	Tank-2	Product Level	+18.000 m/Not Configured	N/A		NOAC1001101101	
11/02/2014 12:06:00 PM	ALARM	INACTIVE	UNACK	Low Low Alarm	Tank-2	Product Level	+2.000 m/Not Configured	N/A		NOAC1001101101	
11/02/2014 12:06:00 PM	ALARM	INACTIVE	UNACK	Low Alarm	Tank-2	Product Level	+2.000 m/Not Configured	N/A		NOAC1001101101	
11/02/2014 12:06:00 PM	ALARM	ACTIVE	UNACK	High Alarm	Tank-2	Product Level	+18.000 m/Not Configured	N/A		NOAC1001101101	
11/02/2014 12:06:47 PM	ALARM	ACTIVE	ACK	High High Alarm	Tank-1	Product Level	+18.000 m/Not Configured	N/A		NOAC1001101101	

Alarm\_Overview



When more than one user acknowledges the alarm at the same time, the system will record the first user as a user who acknowledged the alarm. For all other users, the system will display the error message "Alarm has already been acknowledged".

## Error Messages

1. "You Do Not Have Access Rights to Acknowledge Alarms!"  
This message appears if you do not have authority to acknowledge an alarm. Only the user with valid access rights (for example, supervisor/ technician) can acknowledge an alarm.

### 7.18.5 Alarm Pop up Agent

- The Alarm Pop up Agent is a windows program installed on a PC, connecting to NXA820/ NXA821.
- The program is running in the background and scans for alarms generated in NXA820/ NXA821.
- If an alarm is present, a pop up window opens displaying the alarm.
- The alarm can be acknowledged within this window.
- The window can only be closed if no alarm is active.
- Multiple NXA820/NXA821 can be configured with single Alarm Pop up Agent application

In case an alarm is present the Alarm pup up agent pops up and stays in front of all open windows (and can't be closed with an active alarm). Also a horn sound is present (for the Max. Fill alarm (MF) the sound is different to the other alarms as is has a lower severity).

By selecting one alarm in the left list more information is shown on the right side:

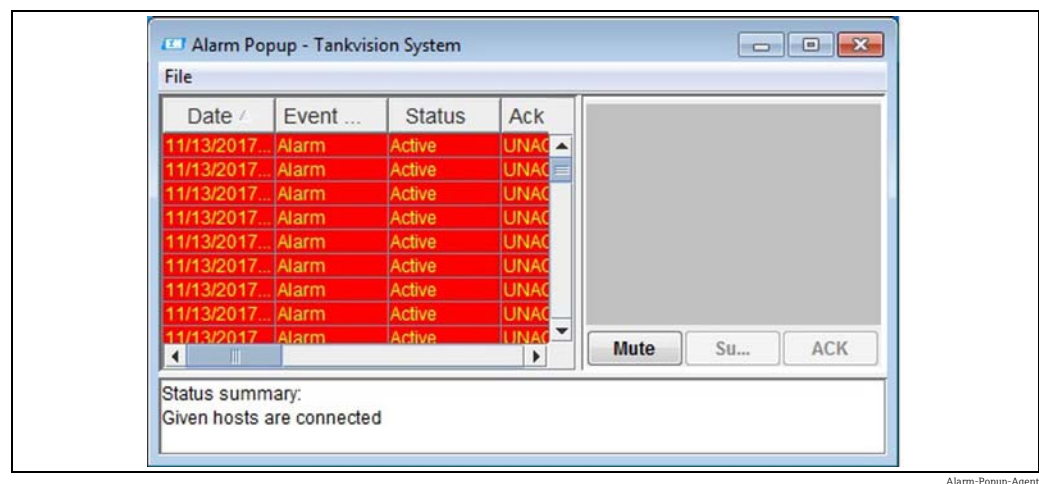

Alarm-Popup-Agent

With clicking on the button **Mute** the sound can be switched off. By clicking on the button **Summary** a browser window/tab opens showing the present alarms and events (→ 63, "Overview of the Alarm and Event Panel").

By clicking on **ACK** the alarm gets acknowledged in the pop up agent and the system (also in Tankvision user interface the alarm is acknowledged). The alarm disappears from the pop up window and the acknowledgment gets recorded in the event log.

Also in the pop up agent the color scheme is followed:  
Inactive alarms are indicated like in the picture below.

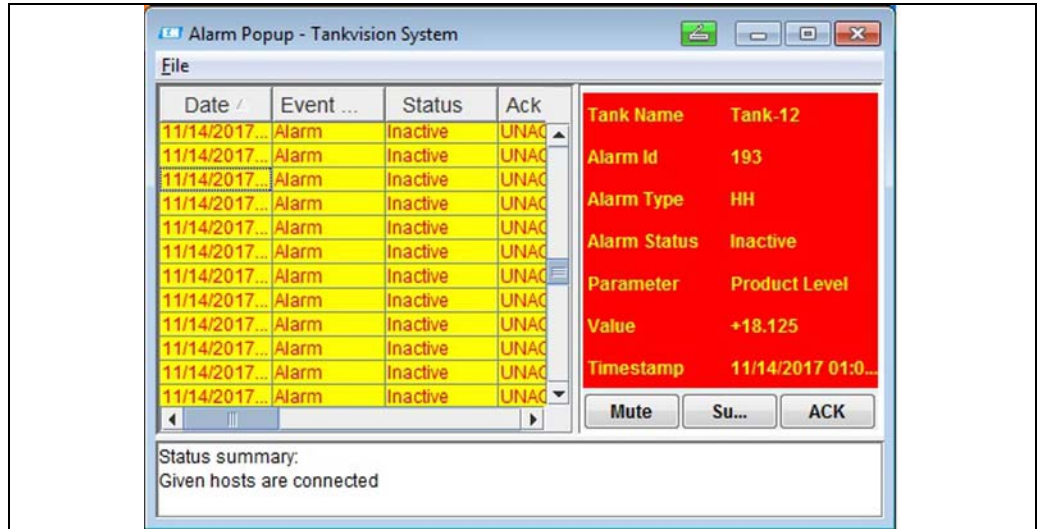

Alarm Popup\_2

To configure multiple Tank scanners, go to "File/Configure" and provide multiple IP Addresses" as shown in below figure. Each IP address has to be entered in a separate line. Press on "Save and Restart" button which will restart the application with the new configuration.

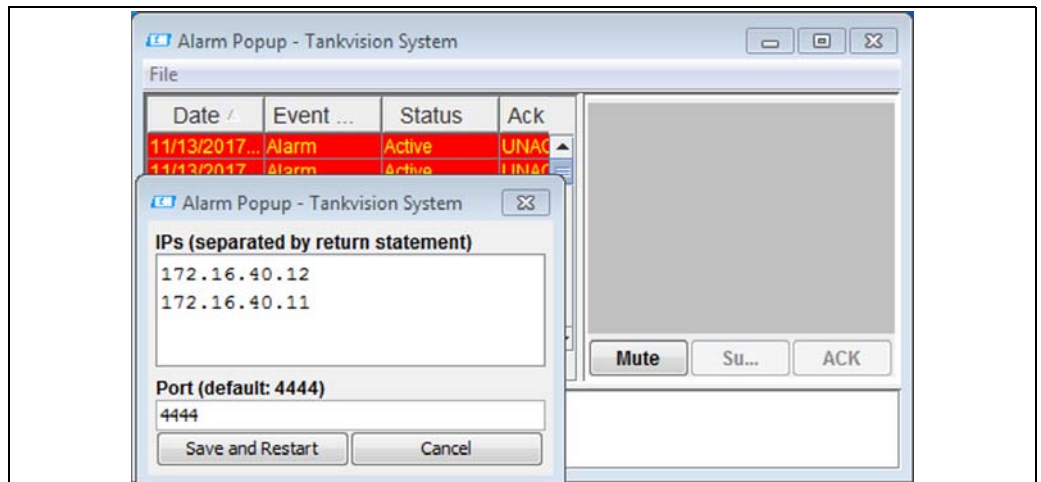

NXA82x\_Alarm-popup

## 7.19 How to select and view historical trends

The below described operations can be performed with the default user access rights for an operator ("User access rights", → 13).

### To view a historical trend

1. In the navigation tree, click **Historical trend** in the **Trends** header. Tankvision displays the screen as follows:

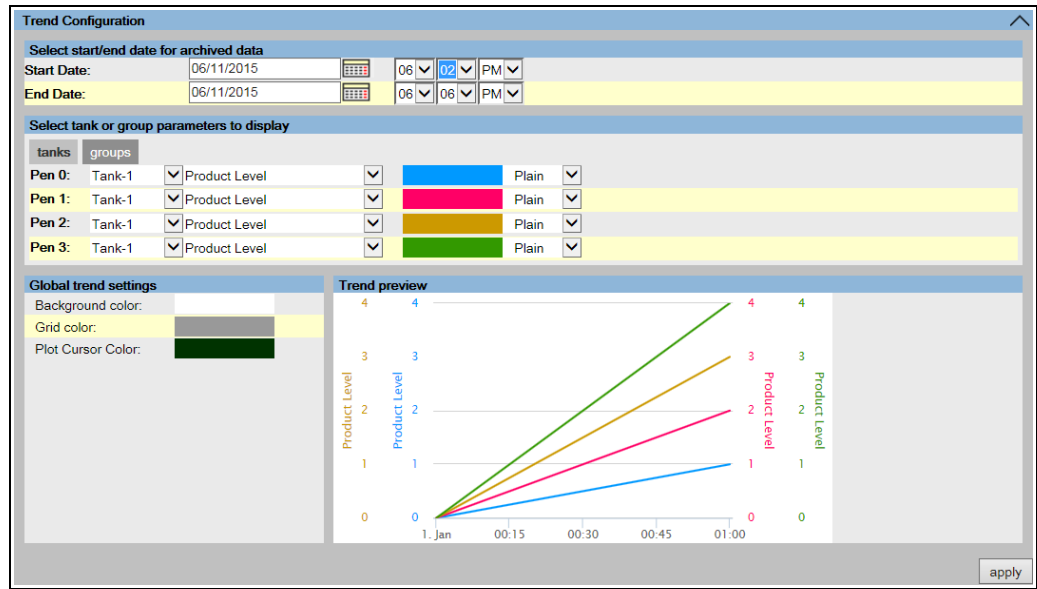

NXA82x\_Trends\_Historical-Trends\_Trend-Configuration

Section	Description
Select start/end date for archived data	Select the interval which should be displayed.
Select tank or group parameters to display	This section displays a list of pens (Pen 0, Pen 1, Pen 2 and Pen 3) that are used to identify the parameters selected. Select <b>tanks</b> or <b>groups</b> tab. Select the appropriate tanks/tank groups, parameters, pen colors and pen style from the respective drop down lists.
Global trend settings	Select the Background color, Grid color and Plot Cursor color from the respective drop down lists.
Trend preview	See a preview of the real time trend plot with the currently selected settings.

2. Select the appropriate settings and click the **apply** button. Tankvision displays the screen as follows:

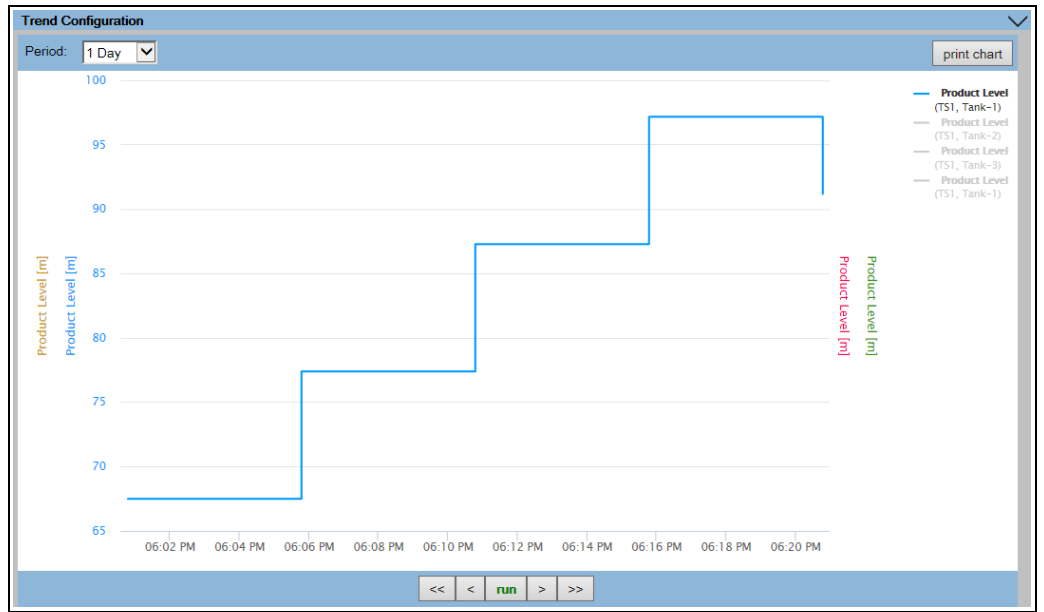

NXAB2x\_Historical-Trend\_Graph

The line graphs are displayed based on the selection of tank parameters in the Trend Configuration area.



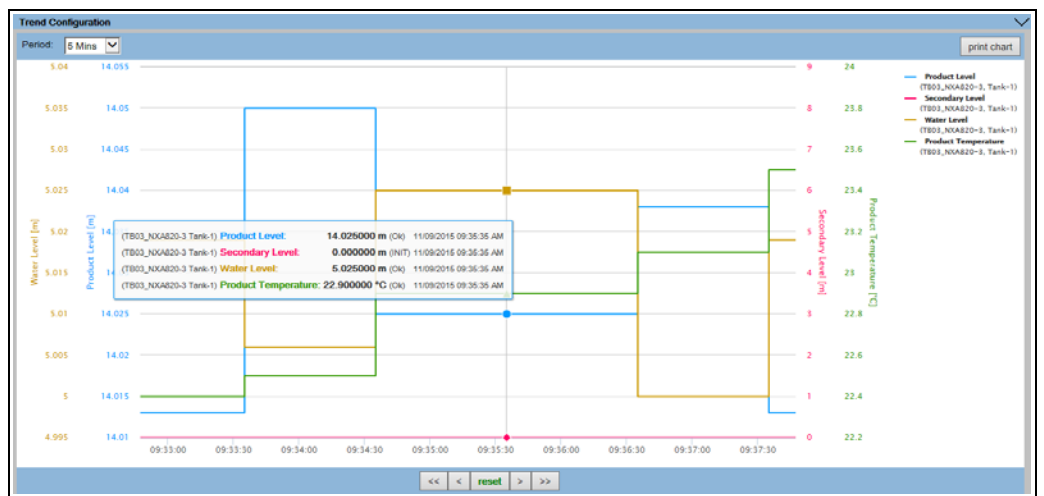

A plotter can be moved through the graphic area. According to the position of the plotter values are displayed in a field next to it. For example:



NXAB2x\_Trends\_Historical-Trends\_Trend-Configuration\_Plotter

Click and drag with the mouse to zoom into the graph.

Field	Description
Period	The Period drop down list allows you to make changes to the currently displayed time window. The selected period is displayed in the plotting area.
print chart	The <b>print chart</b> icon lets you print the current real time trend chart with a connected printer.

Field	Description
Pan	<p>The Pan icons allow you to make changes in the current time window displayed in trend.</p> <p> The <b>Go First</b> button rewinds the trend to the oldest values in the historical trend.</p> <p> The <b>Go Previous</b> button shows the previous time window.</p> <p> The <b>Go Next</b> button shows the next time window.</p> <p> The <b>Go Last</b> button shows the latest values in the historical trend.</p>
run/stop	Without function.

## 7.20 How to check the sealing status

The default user rights of the operator do not allow changes in the settings. Viewing the settings is possible.

1. In the Navigation Tree, click the **System** header. It expands as follows:

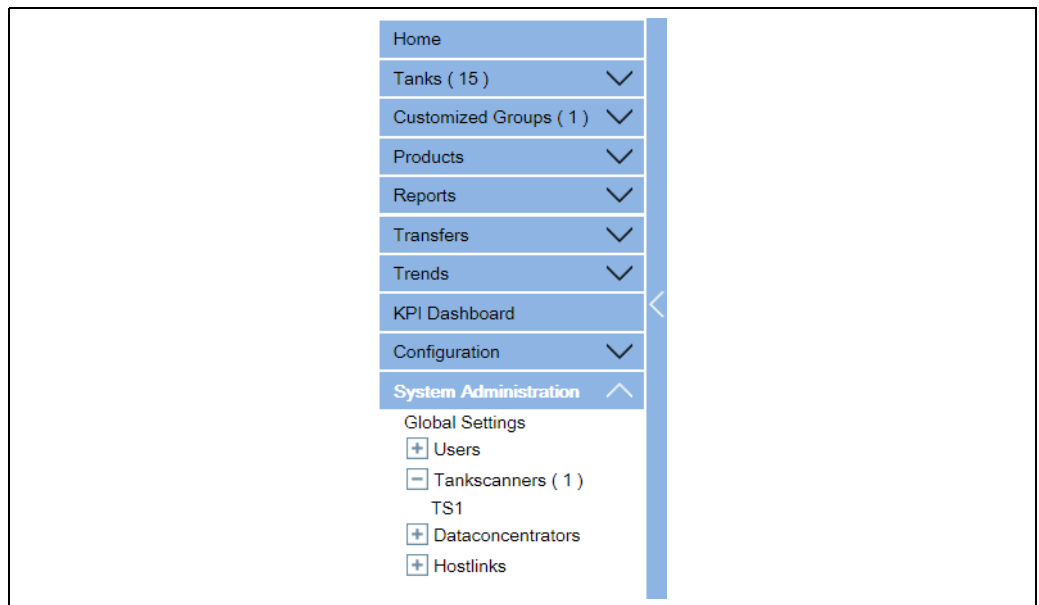

NXA82x\_Menu\_System

2. Click **Global Settings**. Tankvision displays the screen as follows:



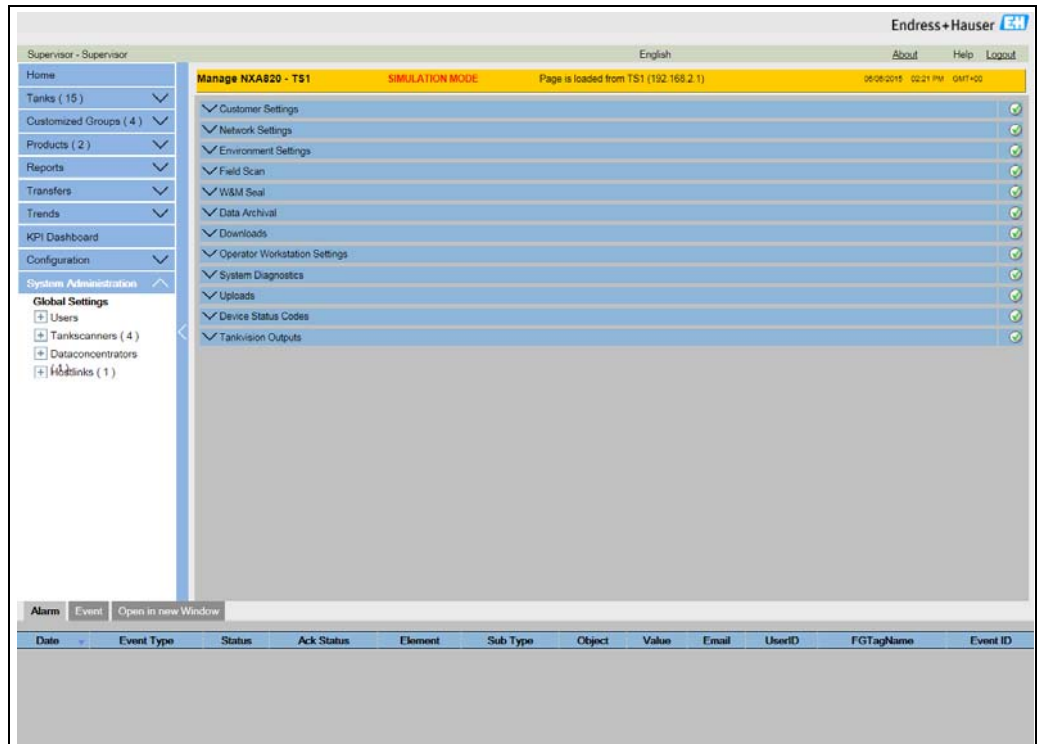

NXA82x\_Global-Settings-Screen

### To view the W&M Approved Status

Click  on **W&M Seal**. Tankvision displays the screen as follows:

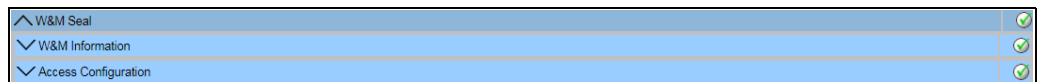

WM\_Seal\_Overview

Field	Description
W&M Information	Shows detailed information of sealing status for a device: <ul style="list-style-type: none"> <li>W&amp;M Switch status</li> <li>W&amp;M CRC at sealing time</li> <li>Time of sealing</li> <li>Last calculated W&amp;M CRC</li> <li>Last calculated CRC's time stamp</li> </ul>
Access Configuration	Registration page to configure access rights for a PC that can access the device after sealing.

### 7.20.1 W&M Information

Click  on **W&M Information**. Tankvision displays the screen as follows:

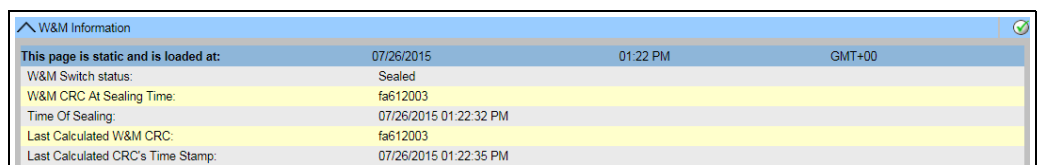

WM\_Information

Field	Description
This page is static and is loaded at:	Displays the date and time when the screen was locked. This is a static page meaning no auto update is running.
W&M switch status	Displays the current W&M switch status. The status can be sealed (closed W&M switch) or unsealed (open W&M switch).
CRC at sealing time	A checksum is calculated with closing the W&M switch. This checksum is displayed in this field.
Time of sealing	Displays the date and time the sealing took place.
Last Calc. W&M CRC	Displays the latest calc. W&M checksum. The checksum is recalculated on a regular basis. In case of a mismatch of the recalculated checksum with the initial checksum, the system was manipulated.
Last calc. W&M CRC time stamp	Displays date and time of the last calculated W&M checksum.

The **W&M CRC at sealing time** and the **Last calc. W&M CRC** must be identical.  
The **Last calc. W&M CRC time stamp** must not be older than 9 h.

## 8 Diagnostics and troubleshooting

### 8.1 General troubleshooting

Finding	Solution
The user interface is not loaded completely	<ol style="list-style-type: none"> <li>1. Press F5 or the reload button in the browser navigation bar.</li> <li>2. If the above didn't resolve the issue check if the compatibility mode (Internet Explorer 8 or 9) is switched on. If PC user rights do not allow performing the action above contact the supervisor.</li> <li>3. If the above didn't resolve the issue delete the cache of the browser (recommendation: Reduce the cache size to 0). If PC user rights do not allow performing the action above contact the supervisor.</li> <li>4. If the above didn't resolve the issue check the settings of the JAVA Runtime (the automatic updates must be switched of and the temporary internet files must be emptied and switched of too). If PC user rights do not allow performing the action above contact the supervisor.</li> </ol>
The IP address is forgotten	The IP address is shown on the local display.
The user interface is out of size	Check the display settings. Recommended resolution is 1280x1024 (or higher)

## 9 Maintenance

There are no special maintenance operations which could be performed by the Operator for the Tankvision Tank Scanner, Data Concentrator, Host Link or OPC Server.

## 10 Repair

### 10.1 Return

The requirements for safe device return can vary depending on the device type and national legislation.

1. Refer to the web page for information:  
<https://www.endress.com/support/return-material>
2. Select the region.
3. Return the device if repairs or a factory calibration are required, or if the wrong device was ordered or delivered.

### 10.2 Disposal



If required by the Directive 2012/19/EU on waste electrical and electronic equipment (WEEE), the product is marked with the depicted symbol in order to minimize the disposal of WEEE as unsorted municipal waste. Do not dispose of products bearing this marking as unsorted municipal waste. Instead, return them to the manufacturer for disposal under the applicable conditions.

# Index

## A

Alarm and Event Panel	12, 63
Alarm Color Schemes	67
Alarm Pop up Agent	68
Alarm Report	58
Alarm Summary	63
Alarms	63
Acknowledging	67
Types	66
Application	6
Assign Product	37

## B

Basic safety instructions	6
---------------------------	---

## C

CE mark	7
Change history	2
Customized Groups	52

## D

Declaration of Conformity	7
Degree of protection	7
Delivery content	8
Density Profiles	26
Diagnostics and troubleshooting	75
Dipped Data	29
Documentation	5

## E

Error codes	
Modbus communication	19
V1	21
Event Report	58
Event Summary	64

## G

Gauge Commands	29
Schedule	29
Send	32

## H

Historical Trends	70
Home Page	10

## I

Icons	4
Incoming acceptance	8
Intended use	6
IT security	7

## L

Logging on	15
------------	----

## M

Maintenance	76
Manual Data	27

## N

Navigation Tree	11
-----------------	----

## O

Open Alarms and Events in new window	65
Operational safety	6

## P

PC configuration	9
Product identification	8
Product safety	7
Product transfer	38
Product Transfer Report	58
Product transfer status	40
Products Groups	49
Product-Tank Group Details	
Graphical View	50
Tabular View	51

## R

Real Time Trend	34
Repair	76
Reports	56
Requirements for the personnel	6

## S

Safety icons	4
Sealing Status	72
Status codes	
Modbus communication	19
V1	21
WM550	22
Storage	9
Symbols	4

## T

Tank Calculations	48
Tank Detail Report	60
Tank details	17
Tank Group Details	
Graphical View	54
Tabular View	55
Tank Groups Details Report	62
Tank Groups Report	61
Tank Report	59
Tank Status	45
Tank Status Change Matrix	45
Tank Status Indicator	46
Temperature Profiles	25
Trademarks	5
Transfer Groups	55
Transfer report	44
Transport	9

## U

User access rights	13
User interface	10

**W**

W&M Information .....	73
WM550 Task-51 .....	25
Workplace safety .....	6





[www.addresses.endress.com](http://www.addresses.endress.com)

---